

Instruction Manual

Turbo Instrument Controller (TIC)

Description

TIC Turbo & Instrument Controller 100W

TIC Turbo & Instrument Controller 200W

Item Number

D397-21-000

D397-22-000



Declaration of Conformity

We, BOC Edwards,
Manor Royal,
Crawley,
West Sussex, RH10 9LW, UK

declare under our sole responsibility that the product(s)

TIC Instrument Controller	D397-00-000
TIC Turbo Controller 100W	D397-11-000
TIC Turbo Controller 200W	D397-12-000
TIC Turbo & Instrument Controller 100W	D397-21-000
TIC Turbo & Instrument Controller 200W	D397-22-000

to which this declaration relates is in conformity with the following standard(s) or other normative document(s)

EN61010-1:2001	Safety requirements for electrical equipment for measurement, control and laboratory use - Part 1: General requirements.
EN61326:1997 + A1:1998 + A2:2001 (Industrial location, Class B Emissions)	Electrical equipment for measurement, control and laboratory use - EMC requirements.

following the provisions of

73/023/EEC	Low Voltage Directive
89/336/EEC	Electromagnetic Compatibility Directive



Dr. J. D. Watson, Director of Technology, VEMD

5 JANUARY 2005 EASTBOURNE

Date and Place

This product has been manufactured under a quality system registered to ISO9001

CONTENTS

Section	Title	Page
1	INTRODUCTION	1
1.1	Scope and definitions	1
1.2	Product description	1
2	TECHNICAL DATA	3
2.1	Electrical data	3
2.2	Operating and storage data	3
2.3	Mechanical data	3
2.4	Connections	4
2.4.1	Active gauge connectors	4
2.4.2	Turbo pump connector	5
2.4.3	Backing pump connector	6
2.4.4	Auxiliary terminals	7
2.4.5	Logic interface	8
2.4.6	Serial communications	9
3	INSTALLATION	11
3.1	Unpack and inspect	11
3.2	Fitting the controller	11
3.3	Controller electrical connections	14
3.3.1	Connecting the electrical supply	14
3.3.2	Additional earth bonding	14
3.3.3	Connecting an active gauge	15
3.3.4	Connecting a turbo pump	15
3.3.5	Connecting a backing pump	15
3.3.6	Connecting a vent valve	15
3.3.7	Connecting an air cooler	16
3.3.8	Connecting the logic interface	16
3.3.9	Connecting the serial interface	19
4	OPERATION	21
4.1	Front panel description	21
4.2	Menu structure	22
4.3	Navigating the menu	24
4.4	The view screen	24
4.5	Turning gauges, pumps and relays ON/OFF	25
4.6	Changing list items	26
4.7	Changing numerical values	26
4.7.1	Entering negative components e.g. 5.00E-03	27
4.8	Pump set up	27
4.8.1	Introduction	27
4.8.2	Default pump set up options	28
4.8.3	Additional set up options using a DX pump	29

CONTENTS (continued)

Section	Title	Page
4.9	Gauge setup	30
4.9.1	Default setup options (all gauges)	31
4.9.2	Gauge status messages	31
4.9.3	Active Pirani Gauge (APG)	31
4.9.4	Active Linear Pirani Gauge (APGX)	32
4.9.5	Active Thermocouple Gauge (ATC-E) control	34
4.9.6	Active Strain Gauge (ASG) control	34
4.9.7	Active Inverted Magnetron (AIM) Gauge control	36
4.9.8	Active Ion Gauge (AIGX-S) control	36
4.9.9	Wide Range Gauge (WRG)	38
4.10	Alarms	40
4.11	The main menu	40
4.12	Pump status	40
4.13	Linking gauges and pumps	41
4.14	Parameters/Units	42
4.15	Screen options	42
4.16	Relay setpoint outputs	42
4.17	Service information	43
4.18	Electrical supply failure	43
5	MAINTENANCE	45
5.1	Safety	45
5.2	Fault finding	45
5.3	Cleaning the controller	46
5.4	Software updates	46
5.5	Factory defaults	47
6	STORAGE AND DISPOSAL	49
6.1	Storage	49
6.2	Disposal	49
7	SERVICE, SPARES AND ACCESSORIES	51
7.1	Service	51
7.2	Spares	51
7.3	Accessories	51
	INDEX	55
	RETURN OF BOC EDWARDS EQUIPMENT	

ILLUSTRATIONS

Figure	Title	Page
1	Pin connections for an 8-way FCC/RJ45	4
2	Pin connections for a 15-way sub-miniature 'D' type socket	5
3	Pin connections for a 15-way sub-miniature 'D' type socket	6
4	4-way screw terminal block	7
5	Pin connections for a 25-way sub-miniature 'D' type socket	8
6	Pin connections for a 9-way sub-miniature 'D' type socket	9
7	Dimensions of a bench mounted TIC (mm)	12
8	Front panel removal	13
9	Rack mounting of a TIC	13
10	Rear panel connections	14
11	IBM PC RS232 interface - 9-way	19
12	IBM PC RS232 interface - 25-way	19
13	RS485 TIC network	20
14	Front panel display	21
15	View screen shortcuts	22
16	Menu structure	23
17	View screen	25
18	Gauge output displayed	25
19	Changing numerical values	26
20	Pump set up screen	27
21	Gauge setup screen	31
22	Gauge setup screen APGX-M	33
23	Gauge setup screen ASG	35
24	Gauge setup screen AIGX	37
25	Gauge setup screen WRG	39
26	Controlled item	41
27	Control setup	41

TABLES

Table	Title	Page
1	Compatible equipment for the TIC range	2
2	Gauge connector pin-out	4
3	Turbo pump connector pin-out	5
4	Backing pump connector pin-out	6
5	Auxiliary connector pin-out	7
6	Logic interface connector pin-out	8
7	Serial communications connector pin-out	9
8	Checklist of components	11
9	Front panel symbols and their functions	21
10	Default pump setup options	28
11	Error/diagnostic monitoring, pumps	29
12	DX pump vent options	29
13	DX pump set up options	30
14	Error/diagnostic monitoring, DX pumps	30
15	Default setup options (all gauges)	30
16	Gauge status messages	31
17	Error/diagnostic monitoring APG	32
18	Setup options APGX	33
19	Error/diagnostic monitoring APGX	33
20	ATC-D and ATC-M gauge tubes	34
21	Error/diagnostic monitoring ATC-E	34
22	Setup options ASG	35
23	Error diagnostic monitoring ASG	35
24	Error/diagnostic monitoring AIM	36
25	Setup options AIGX	37
26	Error/diagnostic monitoring AIGX	38
27	Setup options WRG	38
28	Error/diagnostic monitoring WRG	39
29	Fault finding	45
30	Factory default settings	47
31	Accessories	51

1 INTRODUCTION

1.1 Scope and definitions

This manual provides Installation, Operation and Maintenance instructions for the BOC Edwards Turbo Instrument Controller (TIC). You must use the Controller as specified in this manual.

Read this manual before you install and operate the BOC Edwards Turbo Instrument Controller. Important safety information is highlighted as WARNING and CAUTION instructions; you must obey these instructions. The use of WARNINGS and CAUTIONS is defined below.

	WARNING Warnings are given where failure to observe the instruction could result in injury or death to people.
---	--

CAUTION Cautions are given where failure to observe the instruction could result in damage to the equipment, associated equipment and process.
--

Throughout this manual, page, figure or table numbers are sequential.

The following IEC warning label appears on the controller:



Warning - refer to accompanying documentation.



From August 2005, BOC Edwards will offer European customers a recycling service.

1.2 Product description

	WARNING Improper use of the equipment could cause damage to it or injury to people. The responsibility for the safe operation and maintenance of the equipment is with the user.
---	--

There are two variants of the combined Turbo and Instrument Controller, both of which are provided with a large clear graphics display, easy-to-use control interface via a touch sensitive keypad, an RS232/485 interface for control and data monitoring on a remote PC and a logic interface for interface with associated system hardware.

The compatible instruments/pumps that can be used with the combined TIC are listed in Table 1.

Turbo Instrument Controller (TIC)

TIC variant	Compatibility
TIC Turbo and Instrument Controller 100 W	Upto 3 active gauges including: APG, APGX, ATC, ASG, AIM, WRG and AIGX EXT75DX - fast ramp 255DX - slow ramp EXT70H + EXDC80 - fast ramp EXT255H + EXDC80 - slow ramp Mains backing pumps, XDS scroll, up to RV12 (via an optional relay box) Air Cooler, ACX70 and ACX250 Vent Valve, TAV5 and TAV6 Bakeout band (via an optional relay box) 24 V backing line valves, LCPV16EKA and LCPV25EKA (via an optional relay box)
TIC Turbo and Instrument Controller 200 W	Same as the 100 W version plus the following: 24 V backing pump EXT255H + EXDC160 - fast ramp 255DX - fast ramp

Table 1 - Compatible equipment for the TIC range

2 TECHNICAL DATA

2.1 Electrical data

Connector type	CEE/IEC 320
Electrical supply	90 to 264 V a.c. 47 to 63 Hz
Power consumption	
TIC Turbo & Instrument Controller 100W	215 VA maximum (D397-21-000)
TIC Turbo & Instrument Controller 200W	350 VA maximum (D397-22-000)
Peak inrush current	11 A at 110 V a.c. } D397-21-000 23 A at 240 V a.c. } D397-22-000
Fuse	The unit is self-protecting and has no user replaceable fuse. The unit will recover once any overload is removed.
Earth Stud	M4

2.2 Operating and storage data

Ambient operating temperature range	0 °C to 40 °C
Ambient storage temperature range	-30 °C to 70 °C
Maximum ambient operating humidity	Max 90% RH non condensing at 40 °C
Maximum operating altitude	3000 m max
IP rating	20

2.3 Mechanical data

Weight	
TIC Turbo & Instrument Controller 100W	1.8 kg
TIC Turbo & Instrument Controller 200W	1.9 kg

Turbo Instrument Controller (TIC)

2.4 Connections

2.4.1 Active gauge connectors

Connector type	FCC/RJ45, 8-way (refer to Figure 1)
Power supply	24 V d.c.
Maximum power rating	21 W total for the three gauges
Input voltage range	-0.5 V to 15 V
Output ID current	33 μ A, 0 V to 13 V
Control output	active: <0.8 V d.c. (2 mA max) inactive: open (internal pull-up to 24 V)
Control input	low: <2.0 V d.c. (I_{out} <160 μ A) high: >3.5 V d.c. (internally pulled up to 24 V)

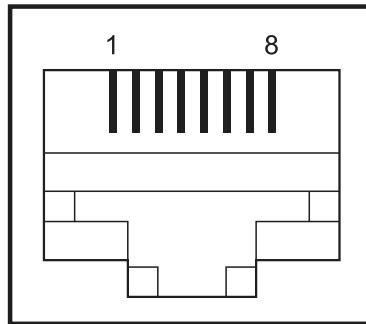

Figure 1 - Pin connections for an 8-way FCC/RJ45

Pin	Allocation
1	Power supply positive
2	Power supply common
3	Signal input
4	Identification
5	Signal common
6	Control line 1
7	Control line 2
8	N/C

Table 2 - Gauge connector pin-out

Turbo Instrument Controller (TIC)

2.4.2 Turbo pump connector

Connector type	15-way sub-miniature 'D' type socket (refer to Figure 2)
Power supply	24 V d.c.
Maximum output power	100 W TIC: 80 W continuous, 120 W peak 200 W TIC: 160 W continuous, 240 W peak (combined total power of the 24 V turbo and backing pumps)
Input voltage range	-0.5 V to 15 V
Output ID current	33 μ A, 0 V to 13 V
Control output	active: <1.1 V d.c. (I_{out} 20 mA max) <0.8 V d.c. (I_{out} <2 mA) inactive: open (<24 V d.c. externally applied)
Control input	low: <4.0 V d.c. (I_{out} <160 μ A) high: 7.0 V to 24 V d.c. (internally pulled up to 24 V)
RS232 transmit	disabled: open enabled: 0: > +8 V (I_{out} max: 8 mA) 1: < -8 V (I_{out} max: -8 mA)
RS232 receive	mark: <4.0 V d.c. (I_{out} < 160 μ A) space: 7.0 V to 24 V d.c. (internal pull up to 24 V)

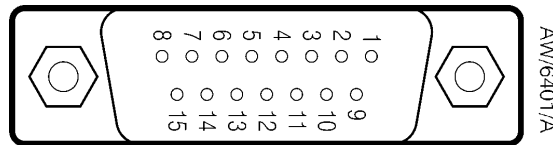

Figure 2 - Pin connections for a 15-way sub-miniature 'D' type socket

Pin	Allocation
1	Power supply positive
2	Signal common
3	/Start signal output
4	RS232 Tx
5	/Serial enable output
6	Power supply positive
7	RS232 Rx
8	Power supply common
9	Speed signal input
10	Screen
11	Power supply positive
12	Screen
13	Power supply common
14	Power supply common
15	Normal signal input

Table 3 - Turbo pump connector pin-out

Turbo Instrument Controller (TIC)

2.4.3 Backing pump connector

Note: Only applicable to the 200W TIC

Connector type	15-way sub-miniature 'D' type socket (refer to Figure 3)
Power supply	24 V d.c.
Maximum output power	160 W continuous, 240 W peak (combined total power of the 24 V turbo and backing pumps)
Output voltage range	Stop = 0 V Start = 10 V (5 mA maximum)
Output ID current	33 µA, 0 V to 13 V
Control output	active: <1.1 V d.c. ($I_{out} < 20$ mA) <0.8 V d.c. ($I_{out} < 2$ mA) inactive: open (<24 V d.c. externally applied)
Control input	low: <4.0 V d.c. ($I_{out} < 160$ µA) high: 7.0 to 24 V d.c. (internally pulled up to 24 V)
RS232 transmit	disabled: open enabled: 0: > +8 V (I_{out} max: 8 mA) 1: < -8 V (I_{out} max: -8 mA)
RS232 receive	mark: <4.0 V d.c. ($I_{out} < 160$ µA) space: 7.0 V to 24 V d.c. (internal pull up to 24 V)

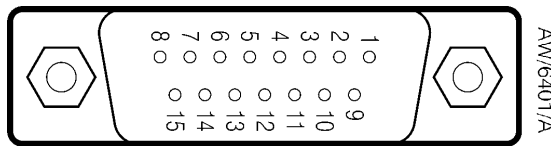

Figure 3 - Pin connections for a 15-way sub-miniature 'D' type socket

Pin	Allocation
1	Power supply positive
2	Signal common
3	/Start signal output
4	RS232 Tx
5	/Serial enable output
6	Power supply positive
7	RS232 Rx
8	Power supply common
9	Speed signal output
10	Screen
11	Power supply positive
12	Screen
13	Power supply common
14	Power supply common
15	Normal signal input

Table 4 - Backing pump connector pin-out

Turbo Instrument Controller (TIC)

2.4.4 Auxiliary terminals

Connector type	4-way screw terminal block (refer to Figure 4)
Wire size	1.5 mm ² max
Power supply	24 V d.c.
Maximum output power	Fan: 3 W max Vent-valve: 2 W max
Control output	active: <1.5 V d.c. inactive: open

AW/6402/A

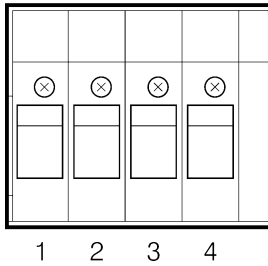

Figure 4 - 4-way screw terminal block

Pin	Allocation
1	Fan control output
2	Fan 24 V
3	Vent control output
4	Vent 24 V

Table 5 - Auxiliary connector pin-out

Turbo Instrument Controller (TIC)

2.4.5 Logic interface

Connector type	25-way sub-miniature 'D' type socket (refer to Figure 5)
Power supply	24 V d.c.
Maximum output power	5 W
Control output	active: <1.1 V d.c. ($I_{out} < 20 \text{ mA}$) <0.8 V d.c. ($I_{out} < 2 \text{ mA}$) inactive: open (internal pull up to 24 V)
Control input	low: <2.0 V d.c. ($I_{out} < 160 \mu\text{A}$) high: 3.5 V to 24 V d.c. (internal pull up to 24 V)
Analogue output	0 to 10 V (5 mA max) 50 mV resolution

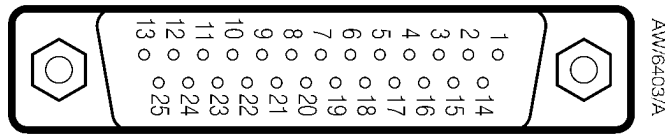

Figure 5 - Pin connections for a 25-way sub-miniature 'D' type socket

Pin	Allocation
1	Screen
2	Analogue output signal
3	Setpoint 1 output
4	Vent control output
5	Bakeout band control output
6	N/C
7	Power supply common
8	Backing pump control output
9	Gauge 1 enable input
10	Power supply common
11	Power supply positive
12	Power supply common
13	Power supply common
14	Analogue output common
15	Setpoint 2 output
16	Setpoint 3 output
17	Turbo normal output
18	Alarm output
19	Air cooler output
20	Gauge 2 enable input
21	Gauge 3 enable input
22	Backing pump enable input
23	Turbo stand-by control input
24	Turbo pump enable input
25	System interlock input (SYSI)

Table 6 - Logic interface connector pin-out

Turbo Instrument Controller (TIC)

2.4.6 Serial communications

Connector type	9-way sub-miniature 'D' type socket (refer to Figure 6)
RS232 transmit	mark: < - 8 V (I_{out} max: -8 mA) space: > +8 V (I_{out} max: -8 mA)
RS232 receive	mark: < +1.0 V (I_{in} max: -2.0 mA) space: >+2.0 V (I_{in} max: +2.0 mA) maximum input: ± 12 V
RS232 protocol	9600 baud, 1 stop bit, 8 data bits, no parity, Xon/Xoff
RS485	Output differential: >1.5 V (I_{out} max: ± 25 mA) Input differential threshold: $>\pm 0.2$ V (I_{in} max: ± 1 mA) Maximum input: -7.0 V to +12 V
Bus load	The TIC applies one unit load to the RS485 bus.

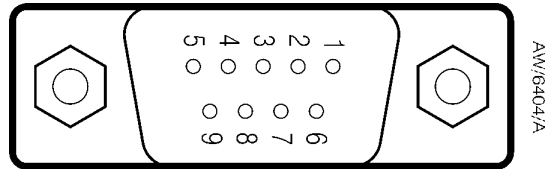

Figure 6 - Pin connections for a 9-way sub-miniature 'D' type socket

Pin	Allocation
1	N/C
2	RS232 transmit
3	RS232 receive
4	N/C
5	RS232 common
6	N/C
7	N/C
8	RS485 data A
9	RS485 data B

Table 7 - Serial communications connector pin-out

This page intentionally blank.

3 INSTALLATION

3.1 Unpack and inspect

Remove all of the packaging material and check the Controller. If the Controller is damaged, follow the BOC Edwards return of equipment procedures that are laid out in the back of this manual. Do not use the Controller if it is damaged.

Check that your package contains the items that are listed in Table 8. If any of these items are missing, notify your supplier in writing within three days. If the Controller is not to be used immediately, store the Controller in suitable conditions as described in Section 6.1.

Quantity	Description	Check(✓)
1	Controller	<input type="checkbox"/>
1	Quick Guide and Health and Safety Information	<input type="checkbox"/>
1	TIC CD	<input type="checkbox"/>
2	Rear non-slip feet	<input type="checkbox"/>
1	Logic interface plug	<input type="checkbox"/>

Table 8 - Checklist of components

3.2 Fitting the controller



WARNING

The Controller contains electrolytic capacitors and, under certain fault conditions, may emit dangerous fumes. Ensure that the Controller is operated in a well-ventilated area.



WARNING

If access to the IEC connector is restricted an additional isolation device should be provided, which will be easily accessible by an operator.

CAUTION

Rubber feet must be fitted (Figure 7, item 1) so that there are correct clearances for air circulation. If you do not, the performance of the Controller may be affected at high operating temperatures.

The Controller can be used on a bench-top or can be fitted in a rack or cabinet. Figure 7 shows the dimensions of the TIC that are required for bench top use.

Note: If the interlocks are not used the logic interface adaptor must be fitted to the 25-way connector.

Turbo Instrument Controller (TIC)

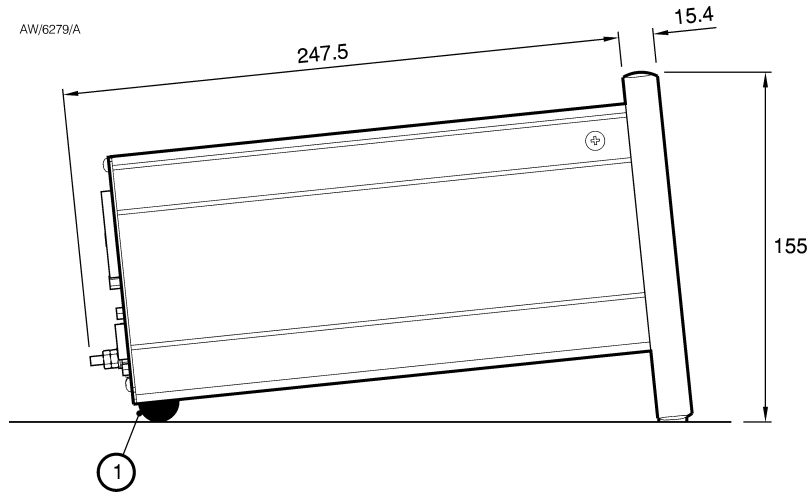

1. Rubber foot

Figure 7 - Dimensions of a bench mounted TIC (mm)



WARNING

Ensure that all electrical wiring is safely secured so that people cannot trip on them.

If a Controller is fitted in a rack or cabinet, follow the directions given in Figures 8 and 9.

CAUTION

Allow 150 mm at the rear for cables. Allow 50 mm top and bottom and 15 mm to the sides for sufficient air circulation. Do not cover any of the ventilation holes.

CAUTION

This unit is IP20 rated. Please ensure that the unit is not installed where fluids can enter into the controller.

Turbo Instrument Controller (TIC)

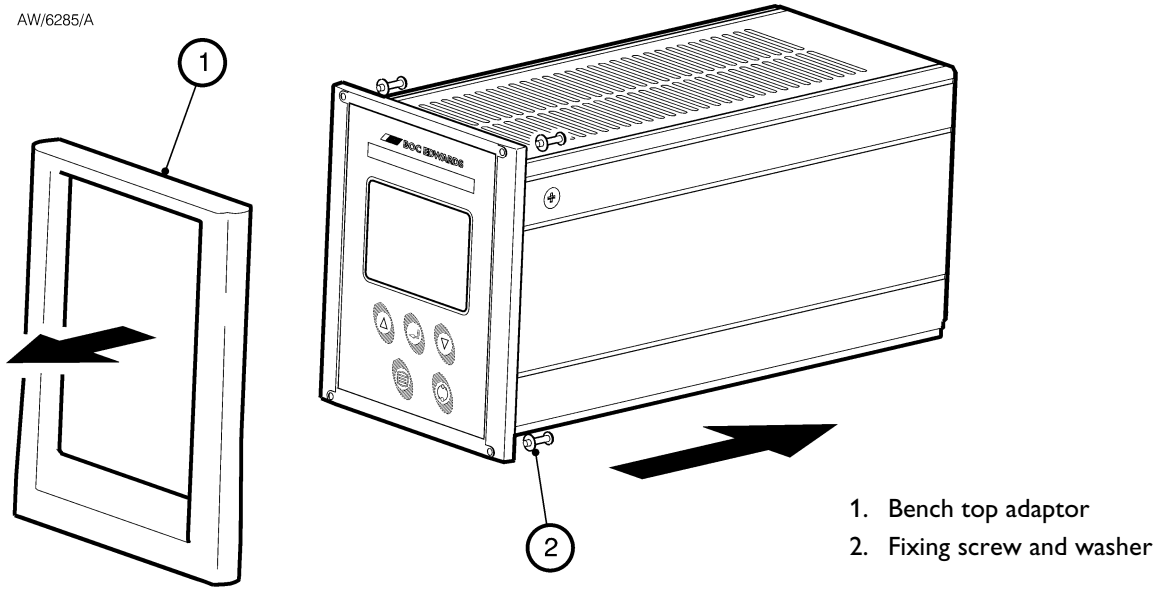

Figure 8 - Front panel removal

- Remove the bench top adaptor (Figure 8, item 1) by removing the four screws (Figure 8, item 2).
- Slide the Controller into the 19" rack. The use of 19" rack guide rails (Figure 9, item 2) is recommended.
- Fix the Controller in place using the four screws removed previously (Figure 9, item 1).

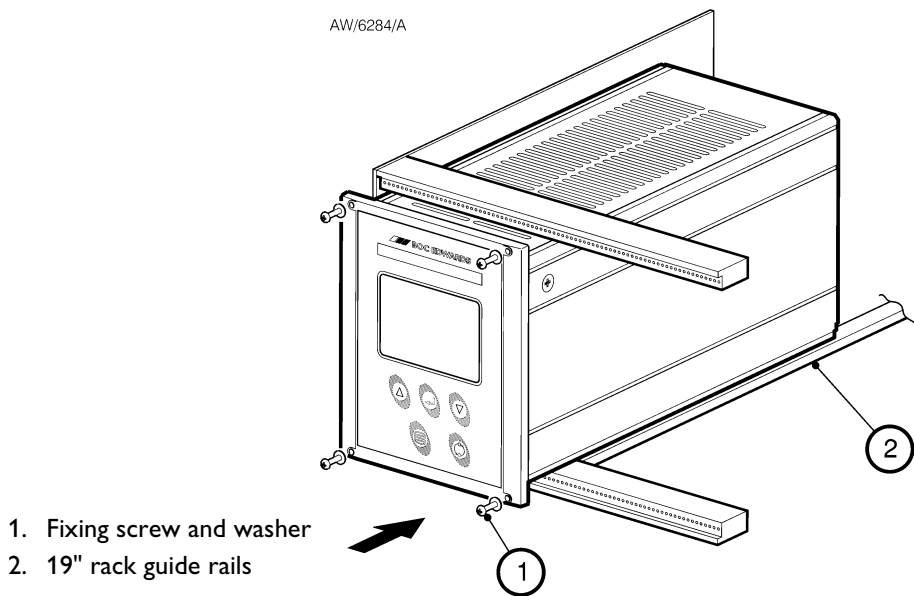

Figure 9 - Rack mounting of a TIC

3.3 Controller electrical connections

CAUTION

Do not connect Barocel capacitance manometers to the TIC. Doing so will result in damage to the gauge and will invalidate the warranty.

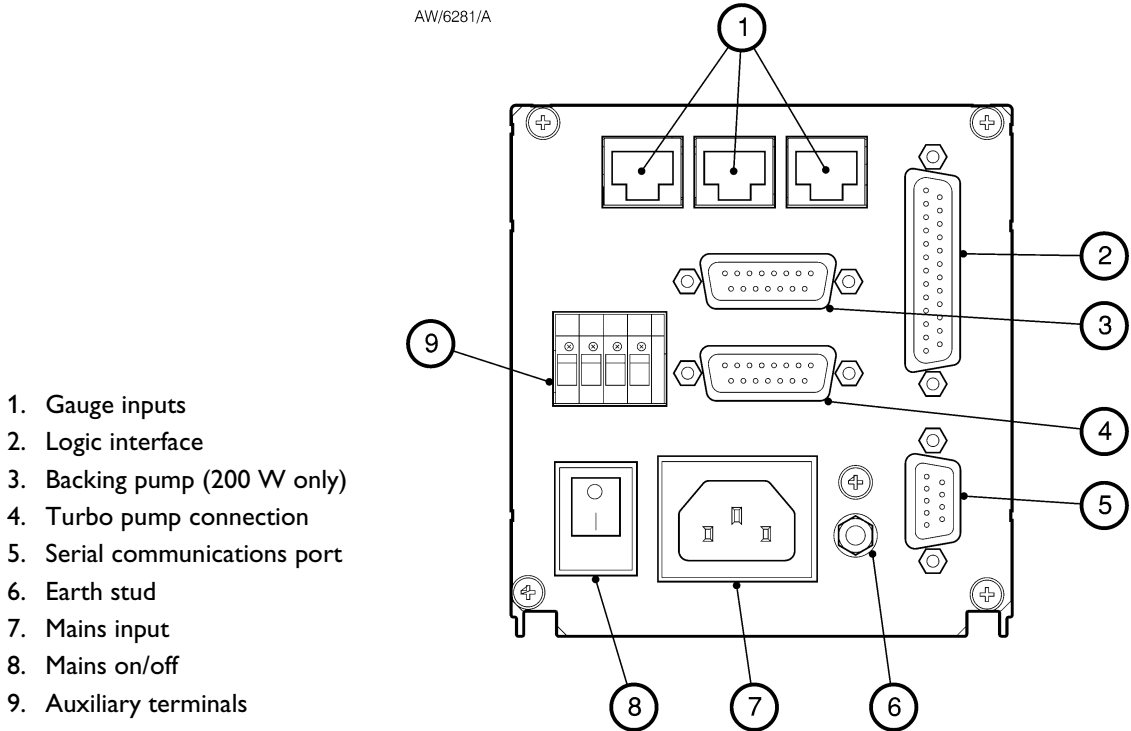

Figure 10 - Rear panel connections

3.3.1 Connecting the electrical supply

WARNING

High voltages exist in the Controller when it is operating. Ensure that the Controller is earthed and observe all appropriate safety precautions for the safe installation and handling of electrical equipment. If you do not, there will be a danger of injury or death to people by electric shock.

Ensure that the electrical supply switch is set to 'off' and then connect the TIC to the electrical supply with an appropriate supply cable.

3.3.2 Additional earth bonding

The electrical supply cable normally provides protective earthing for electrical safety. If this is not the case, or if additional earth bonding is required, then the earth stud on the rear of the Controller (Figure 10, item 6) should be connected to your vacuum system earth.

The earth connection of any vent valves or air coolers should also be connected to this earth stud to ensure that they are adequately earthed.

Connect a suitably earthed cable between the two nuts fitted to the earth stud on the rear of the TIC.

Note: Do not remove the bottom nut from the earth stud.

3.3.3 Connecting an active gauge

CAUTION

Do not connect Barocel capacitance manometers to the TIC. Doing so will result in damage to the gauge and will invalidate the warranty.

Up to three compatible active gauges can be fitted to the gauge connectors on the rear panel. Connect the gauges using Edwards active gauge cables to each of the three gauge sockets on the rear of the TIC.

Note: Only one AIGX gauge can be connected to the TIC at a time.

3.3.4 Connecting a turbo pump

A suitable turbo pump can be connected to the TIC turbo pump connector on the rear panel.

Connect the pump to the lower of the two 15 way 'D' connectors and tighten the locking screws to ensure the connector cannot come loose.

3.3.5 Connecting a backing pump

Both the 100 W and 200 W TICs can control a mains backing pump via the logic interface. For details of this, refer to Section 3.3.8.3.

The 200 W TIC can also drive a suitable backing pump from its second rear panel pump connector.

Connect the pump to the upper of the two 15 way 'D' connectors and tighten the locking screws to ensure the connector cannot come loose.

Note: To control an XDD1 24 V backing pump, the pump must be configured for 'analogue speed control'. Please refer to the pump instruction manual for details on how to configure the pump for this operating mode.

3.3.6 Connecting a vent valve

A vent valve can be driven from either the auxiliary terminals on the rear of the TIC, or from the logic interface. For details of using the logic interface to control a vent valve, see Section 3.3.8.3.

Note: If a DX pump is to be used, it is recommended that the vent valve is connected to the pump, not the TIC Controller. If two vent valves are required, both the DX and TIC vent outputs can be used at the same time. (Refer to Table 12).

Connect the positive lead of the vent valve to the terminal marked 'Vent +', connect the negative lead of the vent valve to the terminal marked 'Vent -', and clamp the earth wire between the earth stud locking nuts on the rear of the controller. Ensure the screws and the earth terminal locking nut, are all firmly tightened.

3.3.7 Connecting an air cooler

An air cooler can be driven from either the auxiliary terminals on the rear of the TIC, or from the logic interface. For details of using the logic interface to control an air cooler, refer to Section 3.3.8.3.

Connect the positive lead of the air cooler to the terminal marked 'Fan +', connect the negative lead of the air cooler to the terminal marked 'Fan -', and clamp the earth wire between the earth stud locking nuts on the rear of the controller. Ensure the screws and the earth terminal locking nut are all firmly tightened.

3.3.8 Connecting the logic interface

3.3.8.1 Introduction

CAUTION

Do not earth the logic interface 0 V lines (pins 7, 10, 12 and 13). If you do, you will provide an earth return path for any electrical fault in the pump-motor and this could damage your Controller or your control equipment.

CAUTION

Do not connect voltages greater than 24 V to the logic interface.

The logic interface provides a number of signals that can be used for monitoring the status of your vacuum system, and for controlling certain aspects of its operation. These signals can be broadly divided into three groups, control inputs, control outputs and status outputs.

3.3.8.2 Using control inputs

Control inputs provide a means of controlling the operation of the TIC and the associated vacuum system from external sources.

Turbo Stand-by: To cause the turbo pump to run at stand-by speed, link 'Turbo Stand-by' to 0 V. To return the pump to full speed, disconnect 'Turbo Stand-by' from 0 V. Note only pumps that have stand-by speed capability will respond to this input.

Turbo Enable: The turbo enable input can be used to control the operation of the turbo pump. If turbo enable is open, the turbo pump cannot be started, and will stop if it is running. If turbo enable is connected to 0 V when power is applied to the TIC, the pump is able to start when commanded to do so. If turbo enable is connected to 0 V while the controller is operating, the turbo pump will start, as long as 'SYSI' and the software configuration allow it to do so.

Backing Pump Enable: The backing pump enable input can be used to control the operation of the backing pump. If backing pump enable is open, the backing pump cannot start, and will stop if it is running. If backing pump enable is connected to 0 V when power is applied to the TIC, the pump is able to start when commanded to do so. If backing pump enable is connected to 0 V while the controller is operating, the backing pump will start, as long as 'SYSI' and the software configuration allow it to do so.

Turbo Instrument Controller (TIC)

Gauge 1, 2, 3 Enable: The gauge enable inputs can be used to control the operation of the gauges. If gauge enable is open, the associated gauge cannot be turned on, and will turn off if it is operating. To enable the gauges, connect the required gauge enable line to 0 V.

Note: Only gauges that can be turned on and off will respond to this input. Refer to the gauge manual for further details.

SYSI: The System interlock input can be used to interlock the TIC to a system fail or control signal. When 'SYSI' is open, all pumps will stop, the vent valve will be opened and gauges will turn off. The TIC will also trip into the fail condition. To clear the system interlock and allow the pumps and gauges to start, connect 'SYSI' to 0 V.

CAUTION

'SYSI' is not fail safe and should not be relied upon for safety critical applications.

Note: Only gauges that can be turned on and off will respond to this input. Refer to the gauge manual for further details.

3.3.8.3 Using control outputs

Control outputs provide a means for the TIC to control external resources.

Vent valve control: The vent valve output can be used to control the operation of a vent valve. The 'Vent Valve' signal will be driven low to energise the valve when required. Connect the positive lead of the vent valve to '24 V' and the negative lead to 'Vent Valve Control'. The vent valve earth lead must be connected to 'Screen' or a suitable alternative earth point.

CAUTION

The vent valve output on the logic interface will not be maintained in the event of a power failure. If venting of your turbo pump while it is running at high speed is undesirable, use the vent valve output from the auxiliary terminals. This output will be maintained during a power failure.

Bakeout band control: The bakeout band control can be used to switch a relay that can apply power to the band. The relay box has a relay built in for this purpose and provides connectors to allow power to be applied to the bakeout band. Refer to the relay box instruction manual for further information on driving a bakeout band.

To drive a relay without a relay box, connect the coil of a suitable 24 V relay between 'Bakeout Band Control Output' (negative) and 'Power Supply Positive' (positive).

Backing pump control: The backing pump control can be used to switch a relay that can apply power to a mains backing pump. The relay box has a relay built in for this purpose and provides a connector that will switch the pump on and off. Refer to the relay box instructions for further information on driving a backing pump.

To drive a relay without a relay box, connect the coil of a suitable 24 V relay between 'Backing Pump Output' (negative) and 'Power Supply Positive' (positive).

Turbo Instrument Controller (TIC)

Air cooler: The air cooler output can be used to control the operation of an air cooler. The air cooler signal will be driven low to energise the cooler when required. Connect the positive lead of the cooler to the power supply positive and the negative lead to 'Air Cooler Control'. The air cooler earth lead must be connected to 'Screen' or a suitable alternative earth point.

3.3.8.4 Using status outputs

Status outputs provide a means for external systems to react based upon the current state of the TIC.

Analogue output: The analogue output provides a 0 V to 10 V signal that can be configured to represent system pressure, pump speed etc. Refer to Section 4.8 for how to configure this output.

To connect this output to an external system, connect the 'Analogue Output Signal' to the positive input of your system and 'Analogue Output Common' to the negative side.

Relay setpoint: The setpoint outputs can be used to interface to external logic or can be used to drive relays. Each output can be configured in software to activate at a certain pressure or pump speed. Refer to Section 4.13 for how to configure these outputs. Each relay can be manually controlled. Refer to Section 4.5.

The relay box has built in relays that can switch external loads and provides a connector to interface to an external system. Refer to the relay box instructions for further information on using the setpoint outputs.

To drive a relay without a relay box, connect the coil of a suitable 24 V relay between 'Setpoint Output' (negative) and 'Power Supply Positive' (positive).

Turbo normal speed: Turbo normal speed can be used to interface to external logic or can be used to drive a relay. This output is normally inactive and will become active when the turbo pump has reached its defined 'Normal' speed.

To drive a relay, connect the coil of a suitable 24 V relay between 'Turbo Normal Output' (negative) and 'Power Supply Positive' (positive).

Alarm: Alarm can be used to interface to external logic or can be used to drive a relay. This output is normally active and will become inactive in the event of an alarm condition.

To drive a relay, connect the coil of a suitable 24 V relay between 'Alarm Output' (negative) and 'Power Supply Positive' (positive).

3.3.9 Connecting the serial interface

The TIC has two serial communications protocols built in, RS232 and RS485. RS232 is the simplest interface and can be used to allow a host PC to control the TIC. RS485 allows a host PC to control a small network of TICs.

3.3.9.1 Connecting RS232

The TIC is fitted with a 9-way 'D' type socket on the rear panel. The interface uses two lines for data transfers and an additional line as a signal common. Hardware handshaking is not implemented.

If connecting to an IBM compatible PC fitted with a 9-way 'D' type socket then a 'straight through' male-female 9-way extension cable can be used to connect the TIC to the computer as shown in Figure 11. Connection to an IBM PC fitted with a 25-way serial connector should be made as shown in Figure 12.

Use shielded cable for the interface to reduce interference problems and limit the length of the RS232 link to less than 10 metres. For longer links, either install line drivers or use RS485.

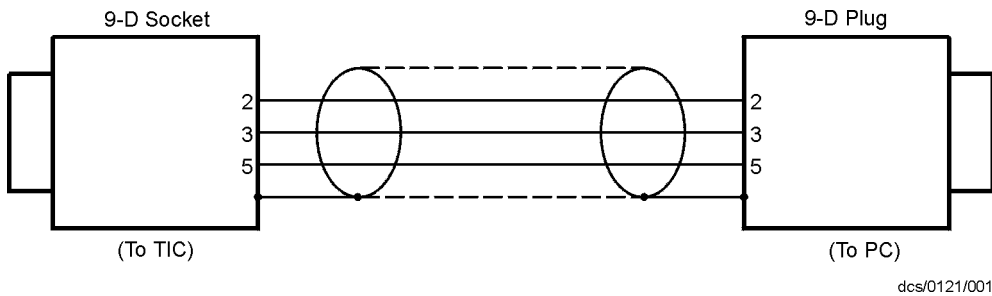

Figure 11 - IBM PC RS232 interface - 9-way

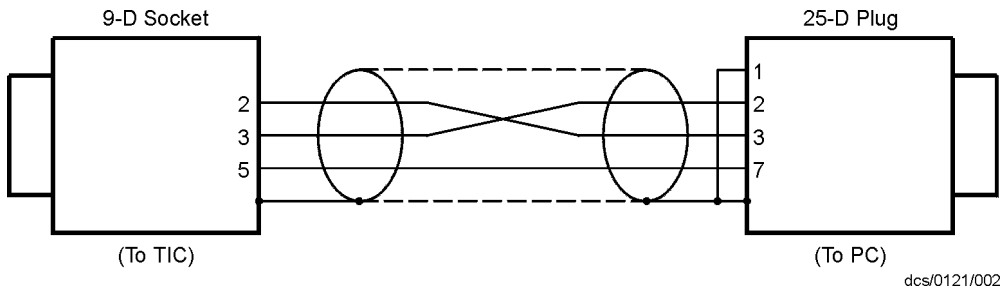

Figure 12 - IBM PC RS232 interface - 25-way

3.3.9.2 Connecting RS485

RS485 provides the TIC with the capability to be networked with other TICs and a host PC as shown in Figure 13.

CAUTION

All of the ground connections are tied together. If differences exist in the local ground voltage, damage could occur. If the TICs being networked are liable to experience different ground potentials, a suitable RS485 isolator should be connected between them.

Use shielded cable for the interface to reduce interference problems and limit the length of the RS485 link to less than 1000 metres.

Long links may require the addition of 120 Ω terminating resistors at each end of the link to improve communications reliability.

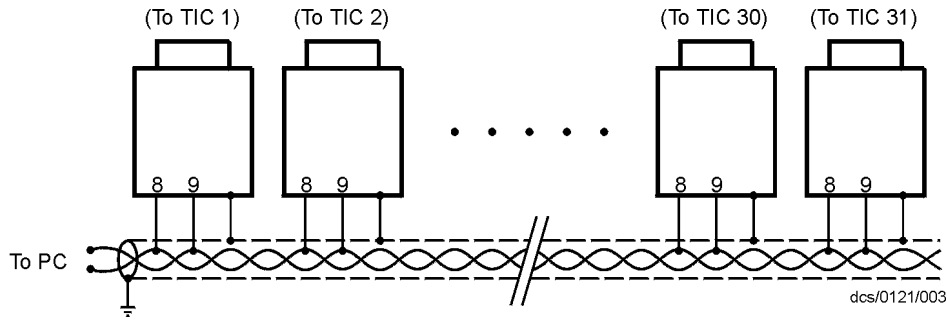

Figure 13 - RS485 TIC network

4 OPERATION

4.1 Front panel description

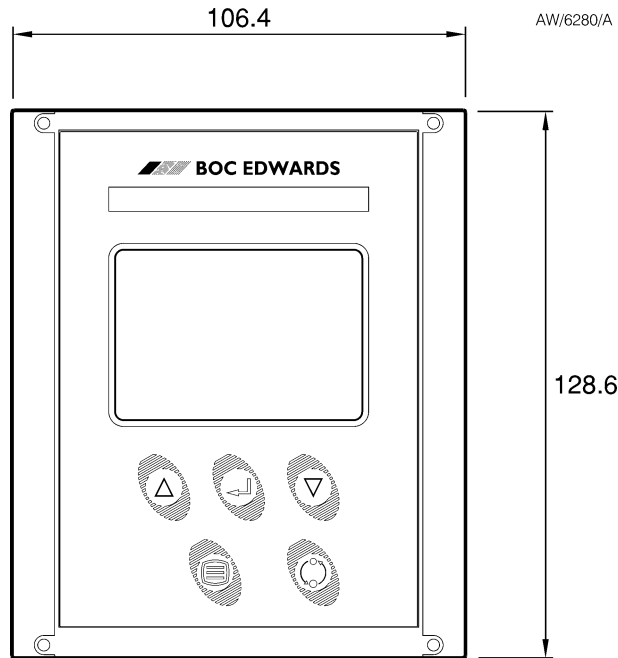

Figure 14 - Front panel display

Symbol	Name	Function
	UP	Move up through a menu. Cycle selected numerical values up. Cycle a selected list item upwards.
	DOWN	Move down through a menu. Cycle selected numerical values down. Cycle a selected list item downwards.
	SELECT	Enter the highlighted sub-menu. Edit the highlighted list or numerical item. Move to the next digit of a numerical value. Jump to the setup screen for the highlighted gauge or pump.
	MENU	Switch between the default view screen and the main menu. Exit the current sub-menu or setup screen. Abort edit of a selected list item. Move to the previous digit of a numerical value.
	CYCLE	Turn a highlighted gauge or pump on or off.

Table 9 - Front panel symbols and their functions

Turbo Instrument Controller (TIC)

4.2 Menu structure

Figures 15 and 16 show the view screen shortcuts and menu structure for the TIC. They also give an indication as to what buttons will take you where within the menu layout.

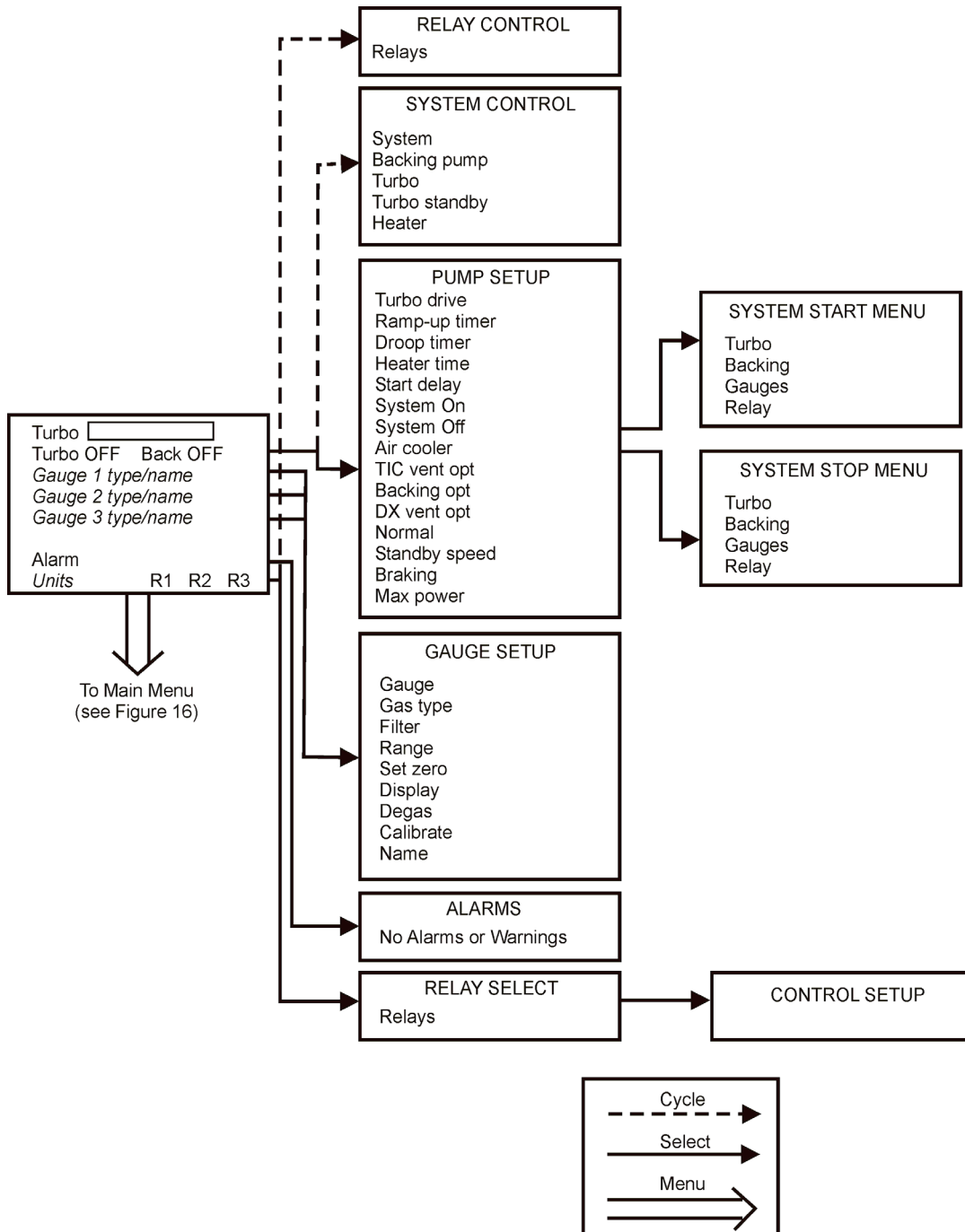

Figure 15 - View screen shortcuts

Turbo Instrument Controller (TIC)

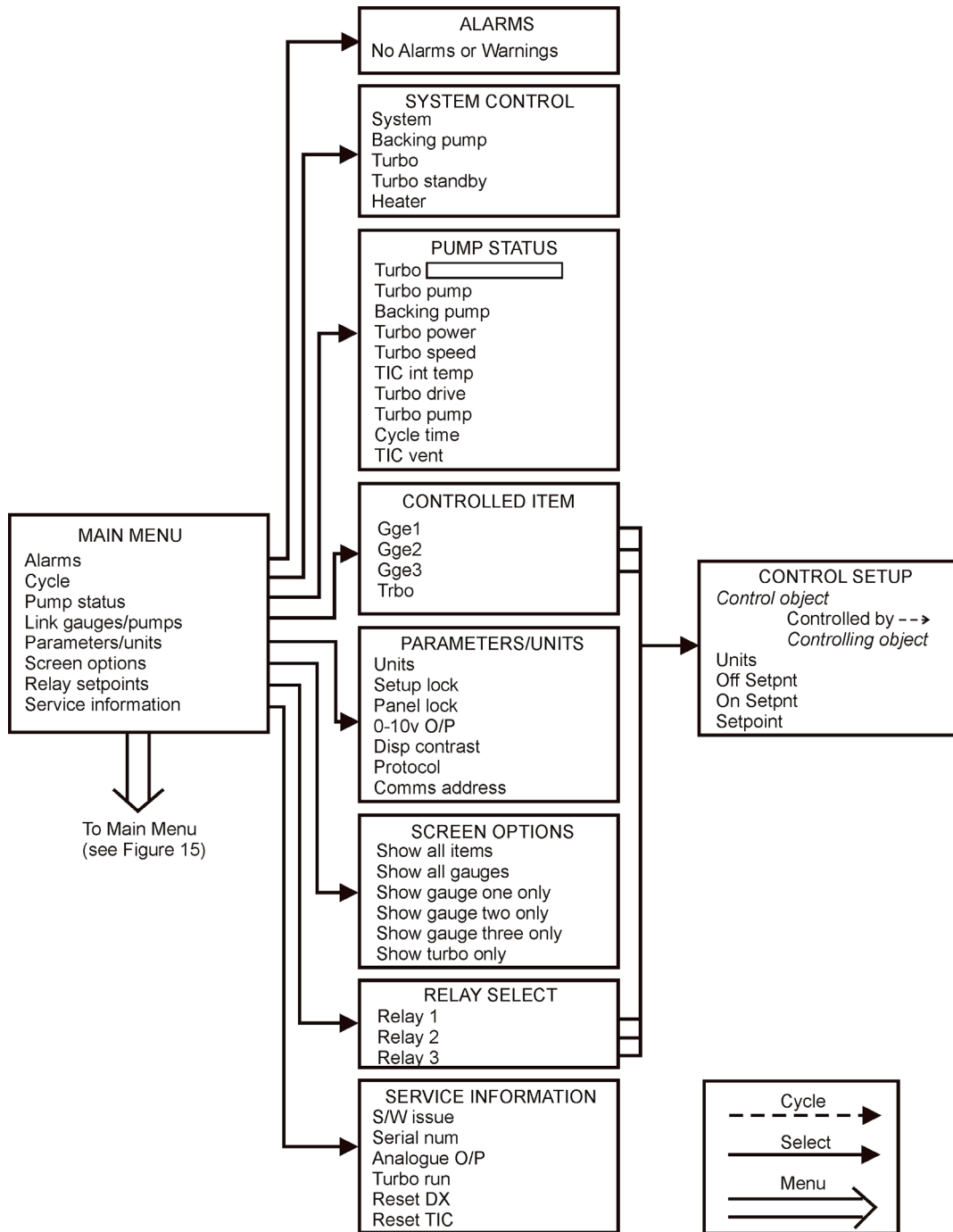

Figure 16 - Menu structure

4.3 Navigating the menu

This section summarises the display navigation method for the TIC. There are 4 buttons for menu navigation and configuration tasks. A fifth button is used for switching pumps/gauges ON and OFF. In most configuration tasks there are no more than three menu levels.

Refer to Table 9 for a description of the functions that the buttons on the front panel perform.

4.4 The view screen

The view screen can be set to various view options; refer to Section 4.14 for the various view screen options which can be set. The following, describes the view screen that shows 'all'. (Refer to Figure 17).

The top portion of the view screen shows the status of the vacuum pumps; the top line shows the pump speed as a bar chart. In the top right-hand corner the status of the turbo pump is shown as follows:

- Off. The turbo pump is off.
- >>>. The turbo pump is accelerating.
- <<<. The turbo pump is decelerating.
- Run. The turbo pump is above 50% speed.
- Norm. The turbo pump is at or above 'normal speed'.
- Strt. The turbo pump is enabled to start, but will not run until the start delay has run down.
- Flt. An error has occurred. Select the alarms screen.

The second line provides the basic status of the turbo pump and backing pump under TIC command.

The status of the setpoint relays is shown at the bottom line of the view screen. Relays that are on are shown in reverse video.

Active gauges are fitted with a resistor that is unique to the type of gauge. When a new gauge is connected, TIC automatically identifies the gauge and indicates that a new gauge has been detected by displaying 'New ID' as shown in Figure 17.

Turbo Instrument Controller (TIC)

dcs/0117/004

Figure 17 - View screen

In this example new gauges have been plugged into channels 1 and 2. Scroll up/down (Δ/∇) to the selected gauge channel and press the 'Select' (\leftarrow) button. The display will identify the gauge type and display either an output or message. Gauges, which measure up to atmospheric pressure (high pressure gauges), will automatically display an output.

4.5 Turning gauges, pumps and relays ON/OFF

Note: If the view screen has been setup to show gauges only, the system can be turned on and off by accessing the cycle menu item in the main menu.

Pressing the 'Cycle' (\odot) button with view screen items selected will turn the items 'on/off'. If the selected item is the turbo/backing status line, a menu of switchable items appear. Use the 'Cycle' (\odot) button to switch the item.



dcs/0117/005

Figure 18 - Gauge output displayed

Low pressure gauges (AIGX and AIM) default to 'OFF', as they should not be operated at pressures greater than their upper range limit. Low pressure gauges may be switched on manually, by scrolling to the display line and pressing the 'Cycle' (\odot) button, or they may be linked to and protected by a suitable high pressure gauge (refer to Section 4.13).

If the selected item is the relay status line, a list of the relays will appear. Scroll to the required relay, use the 'cycle' (\odot) button to switch the item. When the relay is activated the annunciator on the view screen will change to reverse video.



Turbo Instrument Controller (TIC)

Note: Low pressure gauges must be 'enabled' by the Logic Interface before TIC can turn them ON and OFF. This is done either by fitting a link across the appropriate pins on the mating connector, or using an external switch.

The logic interface plug supplied with the TIC has links for this purpose.

If System Interlock (SYSI) is active, pressing the 'Cycle' () button will not switch on low pressure gauges. Conversely, if SYSI is opened during the vacuum cycle, all connected controllable components will be switched OFF.



4.6 Changing list items



To change a list item, scroll to the required line and press the 'Select' () button. The list can then be scrolled using the up and down arrows ( / ).



Pressing the 'Select' () button will accept the adjustment and return the highlight to the row item, allowing another item to be selected for adjustment.

Pressing the 'Menu' () button will cancel the adjustment and return the highlight to the row item, allowing another item to be selected for adjustment.

4.7 Changing numerical values

To change a numerical item, scroll to the required line and press the 'Select' () button. The first number will then be highlighted and can be changed using the up and down arrows ( / ).

The 'Select' () button will move the highlight to the next digit with each successive press, allowing the complete number to be entered. Pressing the 'Select' () button with the last digit selected will accept the adjustment and return the highlight to the row item, allowing another item to be selected for adjustment.

At any time, mistakes can be corrected by pressing the 'Menu' () button. This will move the highlight to the previous digit with each successive button press, allowing corrections to be made. Pressing the 'Menu' () button with the first digit selected will cancel the adjustment and return the highlight to the row item, allowing another item to be selected for adjustment.

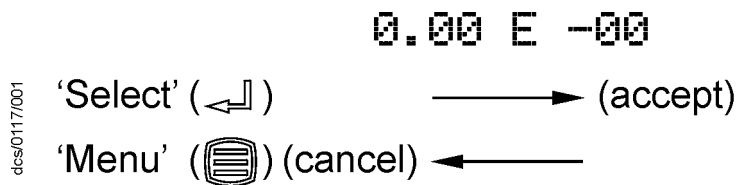

Figure 19 - Changing numerical values

4.7.1 Entering negative components e.g. 5.00E-03

To enter a negative exponent you must first enter the number, then change the sign of exponent. For example, to enter 5.00E-03:

First enter the number using the (Δ / ∇) and (\leftarrow) buttons as above

5.00E + 0 **3**

Then use the 'menu' (\equiv) button to move to the + character

5.00E **+** 03

Use the (Δ / ∇) buttons to change the character to -

5.00E **-** 03

Finally, press the 'select' (\leftarrow) button three times to complete the entry

5.00E - 03

The entry is now complete; use the (Δ / ∇) button to move to the next list item, or the 'menu' (\equiv) button to return to other menus.

4.8 Pump set up**4.8.1 Introduction**

The TIC can be used to configure the EXT and DX pump ranges. The menu screen shows differing functionality depending on the pump attached. The TIC will recognise the pump attached, which will be seen on the pump set up and pump status screen. (Refer to Figure 20).

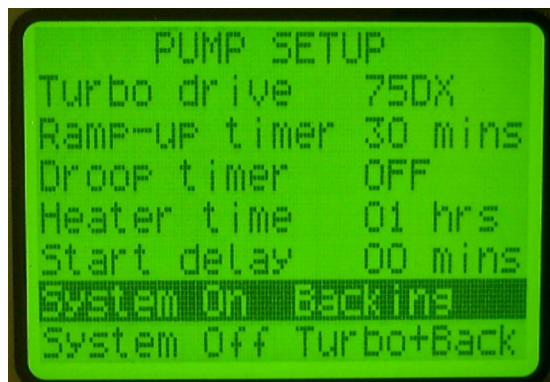

Figure 20 - Pump set up screen

4.8.2 Default pump set up options

Menu option	Description
Ramp Up Timer	The user can set the ramp up timer from 1 to 8 minutes. This timer will generate an alarm if the pump speed does not rise above 50% speed after the set time.
Droop Timer	The user can set the droop time from 1 to 8 minutes. This timer will generate an alarm if the pump speed drops below 50% speed for longer than the specified time.
Heater time	The user can set the time that the heater band bakes out the turbo pump from 0 to 35 hrs. The heater will come on for the set time, once the pump reaches 'normal speed'. If the pump drops below 'normal speed', the heater band will switch off and the timer will be reset.
Start delay	The start delay enables the user to delay the start of the turbo pump from 0 to 99 minutes.
System ON	Allows the user to define the components of the system that are to be turned on, when the 'system' is cycled on.
System OFF	Allows the user to define the components of the system that are to be turned off, when the 'system' is cycled off.
	<i>Note: The system ON and OFF commands provide manual control of the items listed. Where possible it will override settings such as backing options and gauge linking.</i>
	<i>Note: If the backing pump option has been set to 50% or on stop, 'seq' will be indicated showing the backing pump is sequenced to one of the options.</i>
Air cooler	The user can set when a BOC Edwards air cooler should operate. The air cooler can be set to 'ON' (on permanently) or 'Turbo' (on when the turbo pump is running).
TIC vent options	A vent valve attached to the TIC can be operated in the following ways: 'On stop' to open the vent valve 2 seconds after the stop command, or '50%' to open the vent valve when the pump slows to 50% speed.
Backing pump options	A backing pump attached to the TIC or via a relay box can be operated in the following way: None: The backing pump is not sequenced to the Turbo pump 50%: The backing pump will turn off after 2 seconds, once the turbo speed has dropped to 50% of its speed. The delay allows detritus to be removed from the system on stop. On stop the backing pump will turn off 4 seconds after the Turbo off command has been sent. The 4 second delay allows shutting of a valve and then removal of detritus from the system.

Table 10 - Default pump setup options

Turbo Instrument Controller (TIC)

Please refer to Table 11 for error and diagnostic information for pumps.

CAUTION

If an Edwards 24 V backing pump is connected, it is advised that the overall power used does not exceed the data specified in Section 2.

Diagnostic messages	Description
RampUp Timeout	Check whether the pump is too hot or whether the inlet pressure is too high. Check that the backing pump is operational. Check your vacuum system for leaks.
Droop Timeout	Check whether the pump is too hot or whether the inlet pressure is too high. Check that the backing pump is operational. Check your vacuum system for leaks.

Table 11 - Error/diagnostic monitoring, pumps

4.8.3 Additional set up options using a DX pump

The TIC allows the user to set up additional functionality available within a DX pump.

CAUTION

Read the DX pump manual before using the TIC to set up the DX pump.

DX vent options - If a DX pump is attached, the user can set up one of the DX vent options. The user can set up the DX vent, and also the TIC vent to enable two vent valves to be connected to a vacuum system. (Refer to Table 12).

On screen	Description of DX vent function
50%	Vent valve opens fully below 50% full rotational speed for both Stop command or Fail <i>Note: This is the default factory setting.</i>
50%CvV	Controlled venting from 100% - 50% full rotational speed; Vent valve opens fully below 50% for both Stop command or Fail
STP50%	Vent valve opens fully immediately Stop command is received; Vent valve opens fully below 50% full rotational speed if Fail
STPCnV	Vent valve opens fully immediately Stop command is received; Controlled venting from 100% - 50% full rotational speed then vent valve opens fully below 50% if Fail
FLT50%	Vent valve opens fully immediately if Fail; Vent valve opens fully below 50% full rotational speed if Stop
FLTCnV	Vent valve opens fully immediately if Fail; Controlled venting from 100% - 50% full rotational speed then vent valve opens fully below 50% if Stop command received
STPFLT	Vent valve opens fully immediately for both Stop command or Fail
FLTSTP	Vent valve opens fully immediately for both Stop command or Fail
FAN	Vent is Permanently Enabled, and can be used to provide power to a BOC Edwards air cooler

Table 12 - DX pump vent options

Turbo Instrument Controller (TIC)

Menu option	Description
Normal	The TIC allows 'normal speed' to be set as a percentage of full speed.
Standby speed	The user can set the standby speed as a percentage of full speed.
Max power	The user can set the maximum power a DX pump can use.
Braking	Off/Enabled. The user can utilise this function to slow the turbo pump at a quicker rate.

Table 13 - DX pump set up options

Please refer to Table 14 for the error and diagnostic information for DX pumps

Diagnostic messages	Description
Serial ID Fail	A DX or serial pump is connected, however the type has not been recognised. Please check the leads are connected.
DX Fault	Review the flashing error codes on the pump podule, and refer to the DX instruction manual.
SC Interlock	Serial enable to the DX pump was lost while it was running. This could be caused by a temporary loss of power or a broken wire. It is recommended to stop the pump and then restart it. If the alarm does not clear, cycle the controller and then try again.
Uload Timeout	Check that the pump is correctly connected, then try to upload again.
Dload Failed	Check that the pump is correctly connected, then try to download again.

Table 14 - Error/diagnostic monitoring, DX pumps

4.9 Gauge setup

When a new gauge has been identified, scrolling to the selected gauge and pressing the 'Select' (↵) button accesses the 'Gauge Setup' screen. (Refer to Table 15).

Menu option	Description
Gauge	Indicates type of gauge connected.
Gas type	Allows the user to select the gas type. Choice of: N ₂ , He, Ar, CO ₂ , Ne, Kr or Volts. <i>Note: For gas dependent gauges, it is important that the correct gas is selected to ensure correct pressure indication.</i>
Filter	Allows the user to select filter status. Filter 'OFF' gives pressure output as reported by the gauge (update rate 3 per second approx). Filter '1 sec' applies a one second moving average to the readings, reducing the effects of noise on reading stability.
Name	Allows the user to name gauges. 4 characters can be set appropriate to the system, A-Z, 0-9, _ (space). <i>Note: If the gauge name is set the name will appear if the gauge is disconnected. To reset to the gauge type ensure 4 spaces appear in the gauge name setup.</i>

Table 15 - Default setup options (all gauges)

4.9.1 Default setup options (all gauges)

All gauges have the following default items on their respective setup screens. (The example below shows the APGM as the connected gauge).

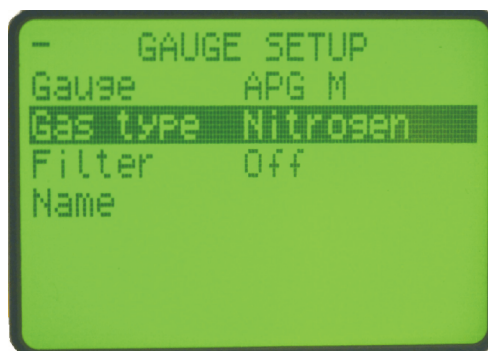

gea/TIC/f21

Figure 21 - Gauge setup screen

Note: Active Strain Gauges (ASG) are gas independent. Selection of any gas type will give the same pressure output.

4.9.2 Gauge status messages

Standard status messages are shown in Table 16.

Diagnostic messages	Description
Not Connected	Indicates that no gauge has been connected to TIC, or if a cable has been connected, the gauge may not be connected to the other end.
NFND	Indicates that the connected gauge is not recognised by TIC. In this case, TIC will continue to display the gauge as NFND and will give an output in volts only.
New ID	Indicates that a new gauge has been connected to TIC. The gauge is recognised by TIC, but must be acknowledged by the user before TIC will allow the gauge to operate on the system.

Table 16 - Gauge status messages

4.9.3 Active Pirani Gauge (APG)

Note: For a detailed specification and instructions regarding the use of the APG and APGX gauges refer to the appropriate Instruction Manual (D021-71-885, D023-71-880 and D023-91-880).

The Active Pirani Gauge (APG) is a gas dependent high-pressure thermal conductivity gauge. The measuring range of the APG-M and the corrosion resistant APG-MP is 100 mbar to 10⁻³ mbar (75 to 7.5 x 10⁻⁴ Torr); the range of the APG-L is 10 mbar to 10⁻⁴ mbar (7.5 to 7.5 x 10⁻⁵ Torr). All of the gauges will indicate pressure up to 1000 mbar (750 Torr) at reduced accuracy.

Note: At pressures above 600 mbar, sensitivity is reduced and TIC displays atmospheric pressure.

Turbo Instrument Controller (TIC)

Note: Before the APG is used and periodically thereafter, atmosphere and vacuum calibration should be carried out in accordance with the directions shown in the Instruction Manual (D021-71-885, D023-71-880 and D023-91-880).

The APG is set up as per the default gauge setup instructions shown in Section 4.9.1 above.

There are no additional setup options for APG. (Refer to Default setup options (all gauges) Section 4.9.1.

There are no error/diagnostic messages specific to APG. (Refer to Table 17).

Diagnostic messages	Description
Over Range	(Gauge output >11.000 V) Indicates that either the measured gas pressure is outside the range of the gauge, or that there is a fault with the gauge. Clear the error message, reduce the process pressure to within the range of the gauge, 'Scroll' to the gauge display line and press 'Cycle'. If the gauge fails to give a pressure readout it should be replaced. This is most likely to occur with gasses of low molecular weight such as Helium.
Under Range	(Gauge output <1.800 V) Indicates that there is either a calibration error, or the gauge is faulty. Calibrate the gauge as described in the instruction manual. If the fault persists, replace the gauge.

Table 17 - Error/diagnostic monitoring APG

4.9.4 Active Linear Pirani Gauge (APGX)

The Active Linear Pirani Gauge (APGX) is a gas dependent high-pressure thermal conductivity gauge. The measuring range of the APGX-M and the corrosion resistant APGX-MP is 100 mbar to 10^{-3} mbar (75 to 7.5×10^{-4} Torr); the range of the APGX-L is 10 mbar to 10^{-4} mbar (7.5 to 7.5×10^{-5} Torr). All of the gauges will indicate pressure up to 1000 mbar (750 Torr) at reduced accuracy.

The Linear Convection Gauges (APGX-H) are gas dependent, high pressure thermal conductivity and convection gauges. The measuring range of the APGX-H is 1333 to 3×10^{-4} mbar (1000 to 2.3×10^{-4} Torr). At pressures above 10 mbar, pressure measurement is by convection, which provides consistent sensitivity and accuracy to the top of the measuring range.

APG(X)s are permanently enabled and hence give an output as soon as they are recognised.

The APGX is set up as per the default gauge setup instructions shown in Section 4.9.1. (Refer to Figure 22).

APGX has menu options in addition to those shown. (Refer to Default setup options (all gauges) Section 4.9.1. (Refer to Table 18).

Turbo Instrument Controller (TIC)

Menu option	Description
Calibrate	Allows the user to adjust the APGX at atmosphere and vacuum. Connect the APGX to TIC and allow it to operate at atmospheric pressure for at least 10 minutes. 'Scroll' to 'Calibrate' and press 'Select'. 'Command Sent' appears for 1 s to confirm instruction has been carried out. Reduce the system pressure to 1×10^{-4} mbar (7.5×10^{-5} Torr) or below for the APGX-M or APGX-MP, or 1×10^{-5} mbar (7.5×10^{-6} Torr) or below for the APGX-L and APGX-H. Repeat the adjustment procedure as described above.

Table 18 - Setup options APGX

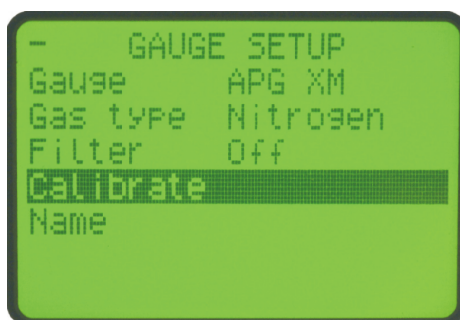

gea/TIC/f22

Figure 22 - Gauge setup screen APGX-M

APGX has an in-built error monitoring capability. (Refer to Table 19).

Diagnostic messages	Description
Over Range	(Gauge output = 9.750 V) Indicates that there is a fault with the gauge and it should be replaced.
Under Range	(Gauge output <0.300 V) Indicates that there is a fault with the gauge and it should be replaced.
Filament Fail	(Gauge output = 9.500 V) Indicates that the gauge filament is broken. The gauge should be replaced.
Cal Error	(Gauge output = 9.600 V) Indicates that the gauge has gone out of calibration. This could be because of the wrong gas type being selected, pressing the atmosphere and vacuum adjustment button in mid-range or contamination of the gauge. The gauge should be re-adjusted as described in Table 18. If the fault persists the gauge should be replaced.
No Tube	(Gauge output = 9.700 V) Indicates that the replaceable gauge tube is missing or incorrectly fitted. Check the tube and ensure that the two fixing screws are properly secured. Note: APGX-H only.

Table 19 - Error/diagnostic monitoring APGX

Note: There is a +/- 50 mV tolerance on the gauge outputs shown in Table 19.

4.9.5 Active Thermocouple Gauge (ATC-E) control

Note: For a detailed specification and instructions regarding the use of the ATC-E, refer to the Instruction Manual (D351-08-880).

Active Thermocouple Gauges are low cost, gas dependent, high pressure, thermal conductivity gauges. The ATC-E electronics module is compatible with two types of thermocouple gauge tube to give a wide measuring range. (Refer to Table 20).

Tube name	Tube part number	Pressure measuring range
ATC-D	D355-12-000	65 to 6.5×10^{-2} mbar (50 to 5×10^{-2} Torr)
ATC-M	D355-13-000	1.3 to 1.3×10^{-3} mbar (1 to 1×10^{-3} Torr)

Table 20 - ATC-D and ATC-M gauge tubes

Before connecting to TIC, the ATC-E must be configured for the type of gauge tube (ATC-D or ATC-M) to be used. This is done by selecting the body colour of the tube with the two-position switch.

Note: At pressures above 600 mbar, ATC-D sensitivity is reduced and TIC displays atmospheric pressure. The ATC-M does not display pressures above 4.2 mbar.

Note: For a valid pressure readout, the switch must be correctly set on the ATC-E.

There are no additional setup options for ATC-E. (Refer to Default setup options (all gauges) Section 4.9.1.

Please refer to Table 21 for the error and diagnostic information for the ATC-E gauge.

Diagnostic messages	Description
Over Range	(Gauge output >11.000V) Indicates that either the measured gas pressure is outside the range of the gauge, or that there is a fault with the gauge. Clear the error message, reduce the process pressure to within the range of the gauge, scroll to the gauge display line and press 'Cycle'. If the gauge fails to give a pressure readout it should be replaced. This is most likely to occur with gasses of low molecular weight such as Helium.
Under Range	(Gauge output <1.500V) Indicates that the gauge is faulty and should be replaced.

Table 21 - Error/diagnostic monitoring ATC-E

4.9.6 Active Strain Gauge (ASG) control

Note: For a detailed specification and instructions regarding the use of the ASG, refer to the Instruction Manual (D357-25-880).

Active Strain Gauges are gas independent diaphragm gauges. There are two gauges with full scales of 2000 and 1000 mbar (1500 and 750 Torr) respectively. Both gauges measure pressures down to 1 mbar (7.5×10^{-1} Torr), have a linear pressure characteristic and output voltage directly proportional to the pressure. The output is 0 to 10 V d.c. over the measuring range of the gauge.

Turbo Instrument Controller (TIC)

ASG has menu options in addition to those shown. (Refer to Default setup options (all gauges) Section 4.9.1. (Refer to Table 22 and Figure 23).

Menu option	Description
Range	Indicates full scale of available gauge options. Choice of: 1000 or 2000
Set zero	Allows the user to zero the gauge. Reduce the system pressure to 2×10^{-2} mbar (1.5×10^{-2} Torr) or below for the 2000 mbar (1500 Torr) ASG or 1×10^{-2} mbar (7.5×10^{-3} Torr) or below for the 1000 mbar (750 Torr) ASG. 'Scroll' to 'Set zero' and press 'Select'. 'Command Sent' appears for 1s to confirm instruction has been carried out.
Display	Indicates pressure display options. Choice of: Float (mantissa and exponent). Fixed (number to 1 decimal place).

Table 22 - Setup options ASG



gea/TIC/f23

Figure 23 - Gauge setup screen ASG

Please refer to Table 23 for the error and diagnostic information for the ASG.

Diagnostic message	Description
Over Range	(Gauge output >11.000 V) Indicates that either the measured gas pressure is outside the range of the gauge, or that there is a fault with the gauge. Clear the error message, reduce the process pressure to within the range of the gauge, scroll to the gauge display line and press 'Cycle'. If the gauge fails to give a pressure readout it should be replaced.
ASG Cant Zero	Indicates that the gauge output is outside the range -100 mV to +100 mV. The most likely cause of this error is either attempting to zero the gauge at too high a pressure or a gauge fault. Attempt to zero the gauge again and if the fault persists, the gauge should be replaced.

Table 23 - Error diagnostic monitoring ASG

4.9.7 Active Inverted Magnetron (AIM) Gauge control

Note: This section covers both standard (AIM-S) and linear (AIM-X) output gauges including low magnetic field (-SL or -XL) and bakeable (type DN40CF) versions.

Note: For a detailed specification and instructions regarding the use of the AIM-S and AIM-X gauges, refer to the appropriate Instruction Manual (D146-41-885 & D146-61-880).

Active Inverted Magnetron (AIM) gauges are gas dependent, cold cathode, ionisation gauges, which measure pressures in the range 1×10^{-2} to 1×10^{-9} mbar (7.5×10^{-3} to 7.5×10^{-10} Torr). There are a number of variants, offering standard (AIM-S) and linear (AIM-X) outputs, low external magnetic field (AIM-SL and AIM-XL) variants for use on sensitive scientific instruments and special bakeable tubes for use in UHV applications.

There are no additional setup options for AIM. (Refer to Default setup options (all gauges) Section 4.9.1.

Please refer to Table 24 for the error and diagnostic information for the AIM gauge.

Diagnostic messages	Description
Over Range	(Gauge output >11.000 V) Indicates that the measured gas pressure is outside the range of the gauge or the wrong gas type has been selected. Check the gas selected is correct, switch off the gauge, clear the error, reduce the process pressure to within the range of the gauge and press 'Cycle'. If the error persists, there is a fault with the gauge and the electronics module should be replaced.
Under Range	(Gauge output <0.025 V) Indicates that there is a fault with the gauge or cable. Replace the cable and if the fault persists, the electronics module should be replaced.
Striking	Indicates that the gauge is attempting to strike. TIC will continue in this mode for up to 15 minutes.
Not Struck	Indicates that the gauge failed to strike within 15 minutes. This is most likely to be because of the gauge tube becoming contaminated. The gauge tube should be inspected for signs of contamination or debris. If the anode and cathode are not bright, the gauge should be cleaned or the electrodes replaced (D145-45-802 or D146-61-802) as described in the AIM instruction manual.

Table 24- Error/diagnostic monitoring AIM

4.9.8 Active Ion Gauge (AIGX-S) control

Note: TIC does not support the AIGX-D variant of the AIGX range. TIC does not support the Ion Gauge Controller (IGC).

Note: For a detailed specification and instructions regarding the use of the AIGX, refer to the Instruction Manual (D048-50-880).

The Active Ion Gauge (AIGX-S) is a fully integrated active instrument, with a measuring range of 6.6×10^{-2} to 6.6×10^{-10} mbar (5×10^{-2} to 5×10^{-10} Torr). The gauge has a 1 volt/decade linear output in the range 0 to 10 V d.c. The AIGX-S is supplied with two filaments, which may be manually selected at the gauge head. For maximum filament life, the gauge includes automatic emission current switching and high-pressure shutdown. The only user selectable features are a setpoint and degas facility.

Turbo Instrument Controller (TIC)

The gauge also includes a comprehensive range of diagnostic outputs, which are displayed on TIC.

AIGX has menu options in addition to those shown. (Refer to Default setup options (all gauges) Section 4.9.1. (Refer to Table 25 and Figure 24).

Menu option	Description
Degas	<p>Allows the user to degas the gauge. 'Scroll' to 'Degas' and press 'Select'. 'Command Sent' appears for 1 s to confirm degas sequence initiated.</p> <p><i>Note:</i> Whilst the gauge is degassing, the pressure output may read slightly higher than normal.</p> <p>The maximum duration of the degas cycle is 3 minutes, during which the pressure shown on the 'View' screen will be suffixed with a 'D'.</p> <p><i>Note:</i> The 'D' is only visible when the channel to which the gauge is connected is NOT selected. This is because the increased size of the text on the selected channel squeezes the 'D' off the screen.</p> <p>At the end of the cycle, the gauge will automatically return to its normal operating mode.</p> <p>If the pressure rises above 1.3×10^{-4} mbar (1×10^{-4} Torr) during the cycle, degas will automatically stop until the pressure falls below 4×10^{-5} mbar (3×10^{-5} Torr), at which point degas resumes for the remainder of the cycle.</p> <p><i>Note:</i> There is no facility enabling degas to be manually switched off mid-cycle.</p>

Table 25 - Setup options AIGX

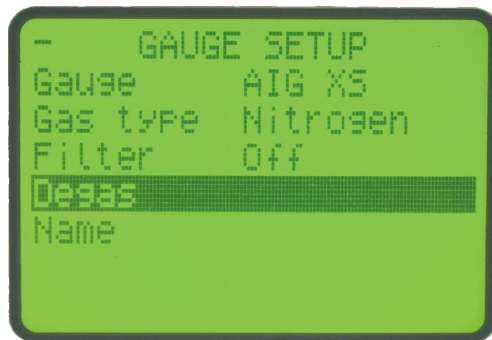

gea/TIC/f24

Figure 24 - Gauge setup screen AIGX

AIGX has an in-built error monitoring capability. (Refer to Table 26).

Diagnostic messages	Description
Over Range	(Gauge output >9.800 V) Indicates that there is a fault with the gauge and the electronics module should be replaced.
Over Pressure	(Gauge output = 9.700 V) Indicates that the gauge has automatically shut down, because of pressure rising above 6.6×10^{-2} mbar (5×10^{-2} Torr). Reduce pressure and re-enable the gauge.
Emission Error	(Gauge output = 9.500 V) Indicates that either the filament is broken (switch over) or gauge was enabled at too high a pressure – reduce and re-enable. Electrical supply is out of spec – check the cables (length and cross section).
Under Range	(Gauge output <0.025 V) Indicates that either the gauge internal fuse has blown or there is a fault with the gauge. The fuse should be replaced as described in the AIGX instruction manual and if the fault persists, the electronics module should be replaced.
Initialising	Indicates that the gauge is establishing an emission current. This usually takes about 5 seconds.

Table 26 - Error/diagnostic monitoring AIGX

4.9.9 Wide Range Gauge (WRG)

Note: For a detailed specification and instructions regarding the use of the WRG, refer to the Instruction Manual (D147-01-885).

The WRG is a combined Pirani and inverted magnetron gauge in a single compact unit. The WRG measures pressure from atmosphere down to 1×10^{-9} mbar (7.5×10^{-10} Torr). The WRG is gas dependent and has a log/linear output in the range 2-10 V d.c. The Pirani part of the gauge measures from atmosphere to 1×10^{-3} mbar (7.5×10^{-3} Torr) while the inverted magnetron measures from 1×10^{-2} down to 1×10^{-9} mbar (7.5×10^{-3} to 7.5×10^{-10} Torr). Output from both sensors is used to determine pressure between 1×10^{-2} and 1×10^{-3} mbar (7.5×10^{-3} and 7.5×10^{-4} Torr).

WRG has menu options in addition to those shown. (Refer to Default setup options (all gauges) Section 4.9.1. (Refer to Table 27 and Figure 25)

Menu option	Description
Calibrate	Allows the user to perform the atmosphere and vacuum adjustment on the WRG. Connect the WRG to TIC and allow it to operate at atmospheric pressure for at least 10 minutes. 'Scroll' to 'Calibrate' and press 'Select'. 'Command Sent' appears for 1s to confirm instruction has been carried out. The WRG will automatically perform a Pirani sensor vacuum setting every time it is pumped down below 1×10^{-4} mbar (7.5×10^{-5} Torr).

Table 27 - Setup options WRG

Turbo Instrument Controller (TIC)

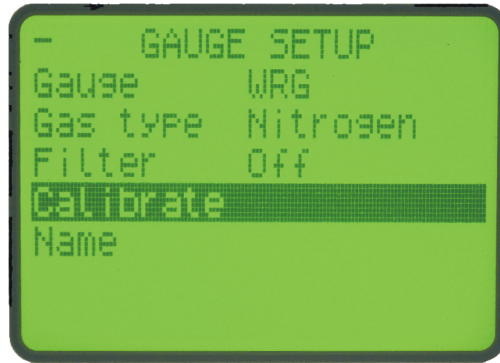

gea/TIC/f25

Figure 25 - Gauge setup screen WRG

Note: If the Pirani sensor is replaced (see WRG instruction manual D147-01-885) it may initially fail to indicate pressures less than 1×10^{-3} mbar (7.5×10^{-4} Torr). In this case a manual vacuum calibration is required.

Pump down to 1×10^{-5} mbar (7.5×10^{-6} Torr) or below before performing the CAL operation as described in the instruction manual.

WRG has an in-built error monitoring capability. (Refer to Table 28).

Diagnostic messages	Description
Over Range	(Gauge output >10.600V) Indicates that there is a fault with the gauge and it should be replaced.
Not Struck	(Gauge output = 1.300V) Indicates that the magnetron part of the gauge has not struck. The gauge tube should be inspected for signs of contamination or debris. If the anode and cathode are not bright, the gauge should be cleaned as described in the WRG instruction manual.
Striker Fail	(Gauge output = 1.200V) Indicates that the striker filament has broken. The electrode assembly (D147-01-802) should be replaced as described in the WRG instruction manual.
Mag Fail	(Gauge output = 1.100V) Indicates that the magnetron part of the WRG has shorted out. This could be because of contamination or a foreign body. The WRG should be cleaned as described in the instruction manual. If this fails to rectify the fault, the WRG should be serviced and the electrode assembly (D147-01-802) replaced as described in the instruction manual.
Filament Fail	(Gauge output = 1.000V) Indicates that the Pirani element of the gauge has failed. The most likely fault being a broken filament. The WRG should be serviced as described in the instruction manual.
Under Range	(Gauge output <0.950V) Indicates that there is a fault with the gauge and the electronics module should be replaced.

Table 28 - Error/diagnostic monitoring WRG

4.10 Alarms

If an Alarm occurs, an 'Alarms' warning will begin flashing in the lower half of the view screen. Refer to Figure 17.

The Alarm can then be selected by moving the cursor over it and pressing the 'Select' (↵) button. This action will take you to the Alarms screen. Alternatively the Alarms screen can be accessed through the main menu.

The Alarm will stop flashing when it has been acknowledged and will disappear when the alarm situation no longer exists. An alarm is acknowledged by pressing the 'Select' (↵) button whilst the flashing alarm is highlighted.

To clear an alarm you will need to refer to the fault finding guide in Section 5 of this instruction manual. This guide gives information of what the alarm is and the possible solutions for clearing the alarm.

4.11 The main menu

The main menu can be accessed by pressing the 'Menu' (☰) button on the view screen (refer to Figure 14). From here the following sub-menus can be accessed.

4.12 Pump status

This screen allows the user to view the current status of the Turbo and Backing pumps. Basic information such as:

- Whether the Turbo pump is ON or OFF.
- The state of the turbo pump that the user has requested.
- Whether the Backing pump is ON or OFF.
- The power that the Turbo pump is using.
- The speed of the Turbo pump as a percentage of full speed.
- The temperature of the power supply.
- The temperature of the Turbo drive. (Only on DX pumps).
- The temperature of the Turbo pump. (Only on DX pumps).
- The cycle time is the run time of the current cycle. (Only on DX pumps).
- Where the vent valve is 'on/off'.

4.13 Linking gauges and pumps

When the Link Gauges and Pumps option is selected from the main menu, a list of controllable items (gauges and/or pumps) is displayed, along with the item that is currently controlling each of them. By default, each item is 'Not Linked' indicating that nothing is in control of the item.

There are four steps to set up the link, proceed as follows:

1. Select the controlled item. Scroll to the item that is to be controlled and press the 'Select' (↵) button as shown in Figure 26.

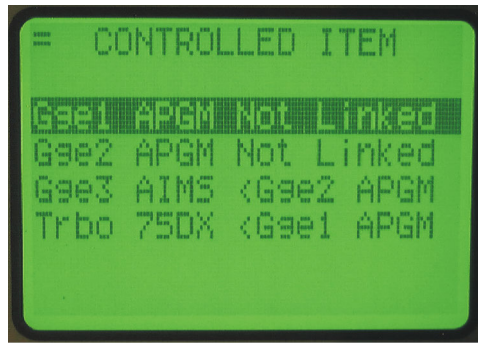

dcx/0117/012

Figure 26 - Controlled item

2. Select the controlling item. The top highlighted line is used to select the controlling item. Select the controlling item from the list of those available and press the 'Select' (↵) button to confirm the choice. As the item type is changed, the units will change to either 'Pressure' for a gauge or 'Speed' for a pump.
3. Enter the required setpoints. The on and off setpoints can be adjusted to suit the application. If the controlling item is a pump, the unit used for the setpoint is speed (%). If the controlling item is a gauge, the units can be changed between pressure (current pressure units) and voltage (V). Select the units to be used and then adjust the on and off setpoints as required as shown in Figure 27.



dcx/0117/013

Figure 27 - Control setup

Note: For gauges: Off setpoint ≥ On setpoint.
 For pumps: Off setpoint ≤ On setpoint.
 If the adjustment of either the On or Off setpoint results in the above rules being broken, the setpoint that was not adjusted will be altered to match the newly entered one.

Note: When entering a pressure, the sign of the exponent can only be changed when the exponent is non-zero. To set a negative exponent, the exponent value should be set first, and then the 'Menu' () button used to move back to alter the sign.

4. Enable the setpoint. Once configured, the setpoint should be enabled by changing the bottom 'Setpoint' line from 'OFF' to 'ENABLED'.

4.14 Parameters/Units

This screen allows the user to change the units that are displayed and other parameters such as:

- Setup lock - When the 3 digit lock code is entered, the lock is enabled and an operator will not be able to change any of the setups, however the operator is still able to scroll through the menus and start and stop pumps. The lock is disabled by entering the 3 digit unlock code again.
- Panel Lock - This function completely locks the front panel. An operator will only be able to see the view screen. The password for this function is shown on the CD inlay card.
- The 0 - 10 V analogue output on the logic interface can be set to follow either gauge 1, 2 or 3, pressure, or turbo speed.
- Display contrast allows the user to change the contrast of the display.
- Protocol shows whether RS232 or RS485 is being used.
- Comms address - To set the comms address of the TIC.

4.15 Screen options

The user can utilise this screen to choose what is to be displayed on the view screen. The options include:

- Show all items - This is the default setting of the view screen.
- Show all gauges - This shows all the gauges in large fonts but not the pump information.
- One gauge at a time - This allows the user to view just a single gauge 3 x height.
- Turbo only - This screen allows the user to view only the Turbo information.

4.16 Relay setpoint outputs

The relay setpoints option allows the setpoint outputs on the logic interface to be linked to a gauge pressure or pump speed. They are set up in the same way as Linking Gauges and Pumps, refer to Section 4.13.

When a relay setpoint becomes active, the R1, R2, or R3 annunciator on the view screen will change to reverse video.

4.17 Service information

Service information contains the following information:

- Software Issue - This is the issue of the currently installed software. This will change when new software is downloaded to the TIC in the future.
- Serial Number - The serial number of the TIC is used when contacting BOC Edwards about the product.
- Analogue O/P - The analogue output value (internal units) is used when contacting BOC Edwards about the product.
- Turbo run - Number of hours the turbo pump has been run (DX pumps only).
- Reset DX - Reset the DX turbo pump to it's factory defaults (DX pumps only).
- Reset TIC - Resets the TIC to it's factory default configuration and can be used to quickly undo all user settings (links between gauges and pumps, relay setpoints, units, gauge gas types, etc.).
- Upload DX - The TIC can store one set of the DX pump's configuration. This function will upload the current configuration from the attached DX pump (DX pump only).
- Download DX - The TIC can download one set of DX configurations to DX pumps, once a configuration has been uploaded. This function will download the stored configuration to the attached DX pump (DX pump only).

4.18 Electrical supply failure

If the electrical supply to the controller fails while the turbo pump is rotating at high speed, the pump begins acting like a generator and will supply power back to the TIC. This power will be used to maintain operation of the vent valve, and if enough power is available the TIC will maintain operation.

The power returned to the TIC is not made available to the gauges, the logic interface or the air cooler; all of these will stop operating until power is restored.

Once the turbo pump speed falls below 50%, the vent valve will open and the TIC will shut down.

This page intentionally blank.

5 MAINTENANCE

5.1 Safety

	WARNING
<p>Obey the safety instructions given below and take note of the appropriate precautions. If you do not, you could cause injury to people or damage to equipment.</p>	

There are no serviceable parts on the TIC. Do not open, return to your nearest BOC Edwards service centre for any repairs that are necessary.

The BOC Edwards return of equipment forms can be found at the rear of this manual.

5.2 Fault finding

	Diagnostic messages	Description
Pump	RampUp Timeout	Refer to Table 11.
	Droop Timeout	Refer to Table 11.
DX	Serial ID Fail	Refer to Table 14.
	DX Fault	Refer to Table 14.
	SC Interlock	Refer to Table 14.
	Uload Timeout	Refer to Table 14.
	Dload Failed	Refer to Table 14.
Gauge	Over Range	Refer to appropriate Section in manual.
	Under Range	Refer to appropriate Section in manual.
	New ID	Refer to Table 16.
	NFND	Refer to Table 16.
	Not connected	Refer to Table 16.
	Not Struck	Refer to appropriate Section in manual.
	Filament Fail	Refer to appropriate Section in manual.
	Mag Fail	Refer to Table 28.
	Striker Fail	Refer to Table 28.
	Cal Error	Refer to Table 19.
	Initialising	Refer to Table 26.
	Emission Error	Refer to Table 26.
	Over Pressure	Refer to Table 26.
ASG Cant Zero	Refer to Table 23.	

(continued)

Table 29 - Fault finding

Turbo Instrument Controller (TIC)

	Diagnostic messages	Description
General	SYSI Inhibit	The system interlock has been disconnected. Please check that the logic interface plug is connected correctly, or check the status of the system interlocks.
	Ext Inhibit	Enable lines have been disconnected, please check your external inhibit lines.
	No Reading	An object has not received a value update from its source within a given time and is flagging that its value is now old. Check connections to components of system.
	No Message	An object has not received a reply to a message it sent within a given time. Check logic interface connections, are correctly attached to the TIC.

Table 29 - Fault finding (continued)

5.3 Cleaning the controller

If necessary, use a soft dry cloth to clean the exterior of the Controller. Do not clean with harsh abrasives or liquids.

If the interior of the Controller requires cleaning, it is our recommendation that you return the Controller to your supplier or your nearest BOC Edwards Service Centre.

5.4 Software updates

The software within the Controller and the TIC PC monitor program will be updated as part of BOC Edwards ongoing development program. The updates and associated instruction manual can be found by visiting www.upgrades.bocedwards.com.

5.5 Factory defaults

The following is a list of factory default settings for the TIC:

Menu option	Default
Pump, gauge and relay slaving	= not slaved
Turbo pump start delay	= 0
EXDC Ramp time	= 8
EXDC Droop time	= 8
Gas type	= Nitrogen
Gauge Filter	= Off
Name	= _ _ _ _ (4 spaces)
ASG range	= 1000
Analogue out slaved	= NONE
TIC vent	= 50%
Heater band	= 0 hrs
Air Cooler	= Turbo
Setup lock	= Off
Panel lock	= Off
Display contrast	= 5
Pressure units	= mbar
PC comms	= RS232
Multi-drop address	= 0
Default screen	= All
ASG fixed/float	= Float
System On	= Backing
System Off	= Turbo
Backing Option	= None

Table 30 - Factory default settings

This page intentionally blank.

6 STORAGE AND DISPOSAL

6.1 Storage

Store the Controller in clean dry conditions in accordance with the technical specifications. Refer to Section 2 of the main manual on CD.

6.2 Disposal

Dispose of the Controller and any components safely in accordance with all-local and national safety and environmental requirements.

Alternatively, you may be able to recycle the Controller and/or cables; contact BOC Edwards or your supplier for advice (also see below).

The Controller and associated cables are within the scope of the European Directive on Waste Electrical and Electronic Equipment, 2002/96/EC. From August 2005, BOC Edwards will offer European customers a recycling service for the Controller/cables at the end of the product's life. Contact BOC Edwards for advice on how to return the Controller/cables for recycling.



WARNING

Do not incinerate the Controller. If the Controller is heated to very high temperatures, dangerous gases may be emitted and internal components may explode.

7 SERVICE, SPARES AND ACCESSORIES

7.1 Service

A worldwide network of BOC Edwards Service Centres supports BOC Edward's products. Each Service Centre offers a wide range of options including equipment decontamination; service exchange; repair; rebuild and testing to factory specifications. Equipment, which has been serviced, repaired or rebuilt, is returned with a full warranty.

For more information about service options, contact your nearest Service Centre or other BOC Edwards company.

7.2 Spares

Spare	Item Number
TIC front Bezel Kit	D397-00-803
Front panel assembly	D397-00-822

Note: This assembly is suitable for customers who have electrical and electronic repair expertise and possess a portable appliance tester. If the customer is unable to carry out this repair, the Controller should be returned to BOC Edwards for a full repair and safety re-test.

7.3 Accessories

Table 31 shows the range of accessories that can be purchased.

Product Description	Ordering Information
TIC Controllers	
TIC Instrument Controller	D397-00-000
TIC Turbo Controllers (100W)	D397-11-000
TIC Turbo Controllers (200W)	D397-12-000
TIC Combined instrument & Turbo Controllers (100W)	D397-21-000
TIC Combined instrument & Turbo Controllers (200W)	D397-22-000
TIC Profibus Module	D397-50-000
Gauges	
APG-M-NW16 AL	D021-71-000
APG-M-NW16 STST	D021-75-000
APG-M-NW25 STST	D021-72-000
APG-M-15mm OD STST	D021-76-000
APG-MP-NW16 STST	D021-85-000
APG-MP-NW25 STST	D021-82-000
APG-MP-15mm OD STST	D021-86-000
APG-L-NW16 AL	D021-73-000
APG-L-NW16 STST	D021-77-000
APG-L-NW25 STST	D021-74-000
APG-L-15mm OD STST	D021-78-000

Table 31 - Accessories

Turbo Instrument Controller (TIC)

Product Description	Ordering Information
APGX-M-NW16 AL	D021-71-000
APGX-M-NW16 STST	D021-75-000
APGX-M-NW25 STST	D021-72-000
APGX-M-15MM OD STST	D021-76-000
APGX-MP-NW16 STST	D021-85-000
APGX-MP-NW25 STST	D021-82-000
APGX-MP-15mm OD STST	D021-86-000
APGX-L-NW16 AL	D021-73-000
APGX-L-NW16 STST	D021-77-000
APGX-L-NW25 STST	D021-74-000
APGX-L-15mm OD STST	D021-78-000
APGX-H-NW16 AL	D023-91-000
APGX-H-NW25 STST	D023-92-000
APGX-H-NW16 STST	D023-95-000
APGX-H-1/8 NPT STST	D023-96-000
ATC-E Electronics Module	D351-08-000
ATC-D 1/8" NPT Gauge Tube	D355-12-000
ATC-M 1/8" NPT Gauge Tube	D355-13-000
ASG NW16 1000 mbar	D357-26-000
ASG NW16 2000 mbar	D357-28-000
ASG 1/8" NPT 1000 mbar	D357-25-000
ASG 1/8" NPT 2000 mbar	D357-27-000
ASG Adaptor Cable 0.5m	D400-03-060
AIM-S-NW25	D146-41-000
AIM-SL-NW25	D146-44-000
AIM-S-DN40CF	D146-61-000
AIM-SL-DN40CF	D146-64-000
AIM-X-NW25	D146-42-000
AIM-XL-NW25	D146-45-000
AIM-X-DN40CF	D146-62-000
AIM-XL-DN40CF	D146-65-000
AIGX-S-NW25	D048-50-000
AIGX-S-DN16CF	D048-51-000
AIGX-S-DN40CF	D048-52-000

Table 31 - Accessories (continued)

Turbo Instrument Controller (TIC)

Product Description	Ordering Information
Active Gauge Cables (including FCC68 compatible connections at both ends)	
0.5m active gauge cable	D400-01-005
1m active gauge cable	D400-01-010
3m active gauge cable	D400-01-030
5m active gauge cable	D400-01-050
10m active gauge cable	D400-01-100
15m active gauge cable	D400-01-150
15m active gauge cable (24 AWG)	D400-05-150
25m active gauge cable	D400-01-250
30m active gauge cable (24 AWG)	D400-05-300
50m active gauge cable	D400-01-500
100m active gauge cable	D400-01-999
Turbo Pumps and Controllers	
EXT70H DN63ISO-K	B722-21-991
EXT70H DN63	B722-22-991
EXT70H DN40NW	B722-23-991
(EXDC80 Control Module required with above Turbo Pumps)	D396-45-000
EXT255H DN100ISO-K	B753-01-991
EXT255H DN100CF	B753-02-991
EXT255Hi DN100ISO-K	B753-03-991
(EXDC160 Control Module required with above Turbo Pumps)	D396-46-000
EXT75DX DN63ISO	B722-41-000
EXT75DX DN63CF	B722-42-000
EXT75DX DN40NW	B722-43-000
EXT75DX DN100ISO	B722-45-000
EXT75iDX DN63ISO (main) / DN25NW (interstage)	B722-38-000
EXT255DX DN100ISO-K	B753-11-000
EXT255DX DN100CF	B753-12-000
EXT255iDX DN100ISO-K (main) / DN25NW (interstage)	B753-13-000
Extension Cables DX/EXDC and 24V backing pumps	
1m DX/EXDC extension cable (16/0.2)	D397-00-835
3m DX/EXDC extension cable (16/0.2)	D397-00-836
5m DX/EXDC extension cable (16/0.2)	D397-00-837
Air Cooler	
ACX70	B580-53-050
ACX250	B580-53-150

Table 31 - Accessories (continued)

Turbo Instrument Controller (TIC)

Product Description	Ordering Information
Vent Valves	
TAV5	B580-66-010
TAV6	B580-66-020
Examples of compatible 24V backing pumps	
XDD1 24 V d.c. Diaphragm pump	A746-01-991
Examples of compatible mains backing pumps	
XDS10 220-240V 50Hz 1-phase	A726-01-903
XDS10 115-120V 60Hz 1-phase	A726-01-906
E2M1.5 220-240V 50/60Hz 1-phase	A371-22-919
E2M1.5 115-120V 50/60Hz 1-phase	A371-22-902
RV12 110-120V 60Hz or 220-240V 50Hz 1-phase	A655-01-903
E2M28 220-240V 50Hz or 230-240V 60Hz 1-phase	A373-15-903
E2M28 115/230V 60Hz 1-phase	A373-15-981
Bakeout band (via optional relay box)	
BX70 240V 30W (EXT70H & EXT75DX)	B580-52-060
BX70 110V 30W (EXT70H & EXT75DX)	B580-52-040
BX250 240V 60W (EXT255H)	B580-52-061
BX250 110V 60W (EXT255H)	B580-52-041
24V backing line valves (via optional relay box)	
LCPV16EKA 24V a.c./d.c.	C417-51-200
LCPV25EKA 24V a.c./d.c.	C417-52-200
Relay Boxes	
TIC Relay box 3 x 240V 3A	D397-00-804
TIC Relay box	D397-11-805
TIC Relay box comb	D397-21-806
Interface cables	
2m Logic interface cable	D397-00-833
2m RS232 interface cable	D397-00-834
Mains cables (Suitable for TIC controllers)	
2m UK plug	D400-13-025
2m USA plug	D400-13-120
2m Northern European plug	D400-13-120
Other accessories and supporting products	
TIC updates, software and manuals	www.upgrades.bocedwards.com

Table 31 - Accessories (continued)

A

Accessories	51
Active gauge connectors	4
Additional earth bonding	14
Alarms	40
Auxiliary terminals	7

B

Backing pump connector	6
------------------------	---

C

Changing list items	26
Changing numerical values	26
Checklist of components	11
Cleaning the controller	46
Connecting a backing pump	15
Connecting a turbo pump	15
Connecting a vent valve	15
Connecting an active gauge	15
Connecting an air cooler	16
Connecting the electrical supply	14
Connecting the serial interface	19
Connections	4
Controller electrical connections	14

D

Default pump setup options	28
Dimensions of a bench mounted TIC (mm)	12
Disposal	49
DX pump set up options	30
DX pump vent options	29

E

Electrical data	3
Electrical supply failure	43
Error/diagnostic monitoring, pumps	29

F

Factory defaults	47
Fault finding	45
Fitting the controller	11
Front panel display	21
Fuse	3

G

Gauge setup	30
-------------	----

I

Installation	11
Introduction	1

L
Linking gauges and pumps 41
Logic interface 8

M
Maintenance 45
Mechanical data 3
Menu structure 22

O
Operating and storage data 3
Operation 21

P
Pump set up 27

R
Rear panel connections 14
Relay setpoint outputs 42

S
Safety 45
Scope and definitions 1
Serial communications 9
Service 51
Service information 43
Software updates 46
Spares 51
Storage 49

T
Technical data 3
Turbo pump connector 5

U
Unpack and inspect 11
Using control inputs 16
Using control outputs 17
Using status outputs 18

Return of BOC Edwards Equipment - Procedure

INTRODUCTION

Before returning your equipment, you must warn BOC Edwards if substances you used (and produced) in the equipment can be hazardous. This information is fundamental to the safety of our Service Centre employees and will determine the procedures employed to service your equipment.

Complete the Declaration (HS2) and send it to BOC Edwards before you dispatch the equipment. It is important to note that this declaration is for BOC Edwards internal use only, and has no relationship to local, national or international transportation safety or environmental requirements. As the person offering the equipment for shipment, it is your responsibility to ensure compliance with applicable laws.

GUIDELINES

- Equipment is '**uncontaminated**' if it has not been used, or if it has only been used with substances that are not hazardous. Your equipment is '**contaminated**' if it has been used with any substances classified as hazardous under EU Directive 67/548/EEC (as amended) or OSHA Occupational Safety (29 CFR 1910).
- If your equipment has been used with radioactive substances, biological or infectious agents, mercury, polychlorinated biphenyls (PCB's), dioxins or sodium azide, you must decontaminate it before you return it to BOC Edwards. You must send independent proof of decontamination (for example a certificate of analysis) to BOC Edwards with the Declaration (HS2). Phone BOC Edwards for advice.
- If your equipment is contaminated, you must either:
 - Remove all traces of contamination (to the satisfaction of laws governing the transportation of dangerous/hazardous substances).
 - Or, properly classify the hazard, mark, manifest and ship the equipment in accordance with applicable laws governing the shipment of hazardous materials.

Note: Some contaminated equipment may not be suitable for airfreight.

PROCEDURE

1. Contact BOC Edwards and obtain a Return Authorisation Number for your equipment.
2. Complete the Return of BOC Edwards Equipment - Declaration (HS2).
3. If the equipment is contaminated, you must contact your transporter to ensure that you properly classify the hazard, mark, manifest and ship the equipment, in accordance with applicable laws governing the shipment of contaminated/hazardous materials. As the person offering the equipment for shipment, it is your responsibility to ensure compliance with applicable law. **Note: Equipment contaminated with some hazardous materials, such as semiconductor by-products, may not be suitable for airfreight - contact your transporter for advice.**
4. Remove all traces of hazardous gases: pass an inert gas through the equipment and any accessories that will be returned to BOC Edwards. Where possible, drain all fluids and lubricants from the equipment and its accessories.
5. Seal up all of the equipment's inlets and outlets (including those where accessories were attached) with blanking flanges or, for uncontaminated product, with heavy gauge tape.
6. Seal equipment in a thick polythene/polyethylene bag or sheet.
7. If the equipment is large, strap the equipment and its accessories to a wooden pallet. If the equipment is too small to be strapped to a pallet, pack it in a suitable strong box.
8. Fax or post a copy of the Declaration (HS2) to BOC Edwards. The Declaration must arrive before the equipment.
9. Give a copy of the Declaration (HS2) to the transporter. You must tell your transporter if the equipment is contaminated.
10. Seal the original Declaration in a suitable envelope: attach the envelope securely to the outside of the equipment package, in a clear weatherproof bag.

WRITE YOUR RETURN AUTHORISATION NUMBER CLEARLY ON THE OUTSIDE OF THE ENVELOPE OR ON THE OUTSIDE OF THE EQUIPMENT PACKAGE.

Return of BOC Edwards Equipment - Declaration

Return Authorisation Number:

You must:

- Know about all of the substances which have been used and produced in the equipment before you complete this Declaration
- Read the Return of BOC Edwards Equipment - Procedure (HS1) before you complete this Declaration
- Contact BOC Edwards to obtain a Return Authorisation Number and to obtain advice if you have any questions
- Send this form to BOC Edwards before you return your equipment

SECTION 1: EQUIPMENT

Equipment/System Name _____

Part Number _____

Serial Number _____

Has the equipment been used, tested or operated ?

 YES Go to Section 2 NO Go to Section 4

IF APPLICABLE:

Tool Reference Number _____

Process _____

Failure Date _____

Serial Number of Replacement Equipment _____

SECTION 2: SUBSTANCES IN CONTACT WITH THE EQUIPMENT
Are any substances used or produced in the equipment:

- Radioactive, biological or infectious agents, mercury, poly chlorinated biphenyls (PCBs), dioxins or sodium azide? (if YES, see Note 1) YES NO
- Hazardous to human health and safety? YES NO

Note 1 : BOC Edwards will not accept delivery of any equipment that is contaminated with radioactive substances, biological/infectious agents, mercury, PCB's, dioxins or sodium azide, unless you:

- Decontaminate the equipment
- Provide proof of decontamination

YOU MUST CONTACT BOC EDWARDS FOR ADVICE BEFORE YOU RETURN SUCH EQUIPMENT

SECTION 3: LIST OF SUBSTANCES IN CONTACT WITH THE EQUIPMENT

Substance name	Chemical Symbol	Precautions required (for example, use protective gloves, etc.)	Action required after a spill, leak or exposure

SECTION 4: RETURN INFORMATION

Reason for return and symptoms of malfunction _____

- If you have a warranty claim:
- who did you buy the equipment from ? _____
 - give the supplier's invoice number _____

SECTION 5: DECLARATION

Print your name: _____ Print your job title: _____

Print your organisation: _____

Print your address: _____

Telephone number: _____ Date of equipment delivery: _____

I have made reasonable enquiry and I have supplied accurate information in this Declaration. I have not withheld any information, and I have followed the Return of BOC Edwards Equipment - Procedure (HS1).

Note: Please print out this form, sign it and return the signed form as hard copy.

Signed: _____ Date _____

This page intentionally blank.

EUROPE/UNITED KINGDOM**BOC EDWARDS**

Manor Royal
Crawley
West Sussex, RH10 9LW
Tel +(44) 1293 528844
Fax +(44) 1293 533453

AMERICAS**USA HEADQUARTERS****BOC EDWARDS**

One Edwards Park
301 Ballardvale Street
Wilmington, MA 01887
Tel +(1) 978 658 5410
Toll Free (USA only) 1800 848 9800
Fax +(1) 978 658 5410

3901 Burton Drive
Santa Clara, CA 95054
Tel +(1) 408 496 1117
Fax +(1) 408 496 1118

1810 West Drake Drive
Suite 101
Tempe, AZ 85283
Tel +(1) 480 777 7007
Fax +(1) 480 777 2244

4117 Commercial Center Drive
Austin, TX 78744
Tel +(1) 512 416 0102
Fax +(1) 512 328 9846

3501 Island Avenue
Philadelphia, PA 19153
Tel +(1) 215 365 8653
Fax +(1) 978 756 6846

U.S. National Sales Center
Mon 8:30 A. M. - 8:00 P.M. EST
Tues 8:30 A. M. - 8:00 P.M. EST
Wed 8:30 A. M. - 8:00 P.M. EST
Thurs 8:30 A. M. - 8:00 P.M. EST
Fri 8:30 A. M. - 6:30 P.M. EST

BELGIUM**BOC EDWARDS**

Bergensesteenweg 709
B1600 Sint-Pieters-Leeuw
Brussels
Tel +(32) 2 363 0030
Fax +(32) 2 363 0064

BRAZIL**BOC DO BRAZIL LTDA**

Rua Bernado Wrona 222
02710 São Paulo-SP
Brazil
Tel +(55) 11 3952 5000
Fax +(55) 11 3965 2766

CANADA**BOC EDWARDS**

5975 Falbourne Street
Mississauga, Ontario L5R3W6
Canada
Tel +(1) 800 387 4076
Fax +(1) 905 501 1225

12055 Cote de Liesse
Dorval, Quebec H9P1B4
Canada
Tel +(1) 514 631 3501
Fax +(1) 514 631 3502

CHINA**BOC TRADING (SHANGHAI)
CO. LTD**

23 Fu Te Road(N),
Wai Gao Qiao Free Trade Zone
Pudong, Shanghai, 200131,
PRC, China
Tel +(86 21) 58669618
Fax +(86 21) 58669993

GERMANY**BOC EDWARDS**

Ammerthalstraße 36
85551 Kirchheim
Munich
Tel +(49) 89 99 19 18 0
Fax +(49) 89 99 19 18 99

FRANCE**BOC EDWARDS**

125 Avenue Louis Roche
92238 Gennevilliers, Cedex
Paris
Tel +(33) 1 47 98 24 01
Fax +(33) 1 47 98 44 54

HONG KONG S.A.R.**BOC EDWARDS (ASIA)**

12 Chun Yat Street
Tseung Kwan O Industrial
Estate
Tseung Kwan O, Kowloon
Hong Kong SAR
Tel +(852) 2372 2640
Fax +(852) 2796 9095

INDIA**BOC EDWARDS****DIVIN. OF BOC INDIA LIMITED**

203 Surya Kiran Building
19 Kasturba Gandhi Marg
New Delhi - 110 001
India
Tel +(91) 11 237 33087
Fax +(91) 11 551 0245

ISRAEL**EDWARDS ISRAEL VACUUM LTD**

5 Habarzel Blvd
Gat 2000 Industrial Zone
Qiryat Gat 82000
Tel +(972) 8 681 0633
Fax +(972) 8 681 0640

ITALY**BOC EDWARDS**

Via Carpaccio 35
20090 Trezzano sul Naviglio
Milan
Tel +(39) 2 48 4471
Fax +(39) 2 48 401638

JAPAN**HEADQUARTERS****BOC EDWARDS**

Shwa Shiba Park Building A-3F
2-4-1 Shibakoen Minato-ku
Tokyo, 105-0011
Tel +(81)(0) 3 5470 6530
Fax +(81)(0) 3 5470 6521

KOREA**HEADQUARTERS****SONGWON EDWARDS LTD**

5th FL. Daewoo Engineering
Bldg.
Soonae-dong
Bundang-gu, Sungnam City
Kyungki-do, Korea
Tel +(82) 31 716 7070
Fax +(82) 31738 1001

SONGWON EDWARDS LTD

625-7 Upsong-dong
Chunan City
Chungchong Nam-do
Korea
Tel +(82) 41 621 7070
Fax +(82) 41 621 7700

SINGAPORE**BOC EDWARDS (ASIA)**

42 Loyang Drive
Loyang Industrial Estate
Singapore 508962
Tel +(65) 546 8408
Fax +(65) 546 8407

TAIWAN, R.O.C.**EDWARDS TAIWAN LIMITED**

No. 434 Chung-hua Road
Toufen Town, Miaoli County
Taiwan R.O.C.
Tel +(886) 37 611422
Fax +(886) 37 611401

PLEASE CONTACT ANY OF THE ABOVE FOR DETAILS OF OTHER SALES AND SERVICE CENTERS IN YOUR AREA.

BOC Edwards is part of BOC Limited. BOC Edwards and the stripe symbol are trade marks of The BOC Group
© BOC Edwards 2004
Publication No. C100-04-895

www.bocedwards.com
info@bocedwards.com

